



QUIVER

DMX CONTROLLER

User Manual
English





INDEX

INDEX.....	2
WARNINGS	5
DISPOSAL OF OLD ELECTRICAL & ELECTRONIC EQUIPMENT	5
GENERAL SAFETY INSTRUCTIONS.....	5
IN CASE OF FAULT	5
PACKAGING, SHIPPING AND COMPLAINT.....	6
WARRANTY AND PRODUCTS RETURN	6
MAINTENANCE AND DISCLAIMER.....	6
POWER SUPPLY	6
CE CONFORMITY	7
WHAT'S IN THE BOX.....	7
GLOSSARY.....	8
INTRODUCTION	11
QUICK GUIDE.....	12
Console Overview	12
Dimensions.....	13
Technical Specifications	14
The Edit Keys	15
Register keys	16
Controller Sliders and Switches	16
Touch Sliders	16
Pan & Tilt aiming	16
Console Setup	17
Produce a Show.....	17
Add fixtures in the library	17
Address Patch: fixture assignment	18
Editor.....	20
Save a Cue/Group/Palette/Snapshot.....	21
Modify a cue.....	21
Palette	21
Playing – cue execution.....	22
REFERENCE MANUAL	23
EDITOR	23



Fixture mode	23
Fixture Mode Contextual Menu.....	25
Group Mode.....	26
Create or modify a group.....	26
Palette	26
Palette mode contextual Menu	27
Create a new palette.....	27
Edit an existing palette.....	27
Color Palette	28
Effects.....	28
Saving an effect as cue.....	29
Edit an existing effect.....	29
FAN.....	30
Color Picker	31
Playback	32
Cue list.....	32
Cue-list in <i>Qlist mode</i>	34
Cue-list in <i>Chase Mode</i>	34
Cue-list in <i>Sequence Mode</i>	35
Cue-list in <i>Live mode</i>	36
Cue-list contextual Menu.....	36
Register Slider: Playback Master.....	37
Cue Priority (LTP/HTP)	38
Execute a cue-list: Register Playback.....	38
Stop a cue-list: Register Release	38
Change the current Register Page	38
Grand master and group submaster.....	39
SETUP	39
Address Patch.....	40
Fixture browser	41
Add Fixtures	42
General options.....	43
Fixture configuration.....	43
Controller configuration	45



Pan Tilt options	45
Backup/Restore.....	46
Backup/Restore contextual menu	47
Library manager	47
Diagnostic.....	49
Wireless configuration	50
QUIVERX EXPANSION	51
Dimensions.....	52
Fixture Editor for Windows.....	53

WARNINGS

Thank You for choosing one of Our products!

Please refer to the instructions and warnings contained in this user manual, please retain it for future reference.

This manual contains information about the installation and use of the device.

The information contained in this publication has been carefully prepared and checked. However, it is not assumed any responsibility for any inaccuracies. All rights are reserved and this document cannot be copied, photocopied, reproduced in whole or in part without previous written permission of PROEL. PROEL reserves the right to make, without notice, any aesthetical, functional or design changes or modifications in every one of its products. PROEL doesn't assume any responsibility for the use or application of the products here described.

DISPOSAL OF OLD ELECTRICAL & ELECTRONIC EQUIPMENT



This marking shown on the product or its literature, indicates that it should not be disposed with other household wastes at the end of its working life. To prevent possible harm to the environment or human health from uncontrolled waste disposal, please separate this from other types of wastes and recycle it responsibly to promote the sustainable reuse of material resources. Household users should contact either the retailer where they purchased this product, or their local government office, for details of where and how they can take this item for environmentally safe recycling. Business users should contact their supplier and check the terms and conditions of the purchase contract. This product should not be mixed with other commercial wastes for disposal.

GENERAL SAFETY INSTRUCTIONS

- **CAUTION** - Before using this product read carefully the following safety instructions. Take a look of this manual entirely and preserve it for future reference. When using any electric product, basic precautions should always be taken, including the following:
- To reduce the risk, close supervision is necessary when the product is used near children.
- Protect the apparatus from atmospheric agents and keep it away from water, rain and high humidity places.
- This product should be placed away from heat sources such as radiators, lamps and any other device that generate heat.
- Care should be taken so that objects and liquids do not go inside the product.
- The product should be connected to a power supply only of the type described on the operating instructions or as marked on the product.

IN CASE OF FAULT

- In case of fault or maintenance this product should be inspected only by qualified service personnel when:
 - Liquids have spilled inside the product.
 - The product has fallen and been damaged.
 - The product does not appear to operate normally or exhibits a marked change in performance.



- Do not operate on the product. Refer servicing to an authorized maintenance center.

PACKAGING, SHIPPING AND COMPLAINT

- This unit package has been submitted to ISTA 1A integrity tests. We suggest you control the unit conditions immediately after unpacking it.
- If any damage is found, immediately advise the dealer. Keep all unit packaging parts to allow inspection.
- Proel is not responsible for any damage that occurs during shipment.
- Products are sold "delivered ex warehouse" and shipment is at charge and risk of the buyer.
- Possible damages to unit should be immediately notified to forwarder. Each complaint for manumitted package should be done within eight days from product receipt.

WARRANTY AND PRODUCTS RETURN

- Proel products have operating warranty and comply their specifications, as stated by manufacturer.
- Proel warrants all materials, workmanship and proper operation of this product for a period of two years from the original date of purchase. If any defects are found in the materials or workmanship or if the product fails to function properly during the applicable warranty period, the owner should inform about these defects the dealer or the distributor, providing receipt or invoice of date of purchase and defect detailed description. This warranty does not extend to damage resulting from improper installation, misuse, neglect or abuse. Proel S.p.A. will verify damage on returned units, and when the unit has been properly used and warranty is still valid, then the unit will be replaced or repaired. Proel S.p.A. is not responsible for any "direct damage" or "indirect damage" caused by product defectiveness.

MAINTENANCE AND DISCLAIMER

- Clean only with dry cloth.
- Proel S.p.A. reserves the right to change these specifications at any time without notice.
- Proel S.p.A. declines any liability for damages to objects or persons caused by lacks of maintenance, improper use, installation not performed with safety precautions and at the state of the art.

POWER SUPPLY

- This apparatus should only be connected to power source type specified in this owner's manual or on the unit.
- If the supplied AC power cable plug is different from the wall socket, please contact an electrician to change the AC power plug.
- Hold the plug and the wall outlet while disconnecting the unit from AC power.
- If the unit will not be used for a long period of time, please unplug the power cord from AC power outlet.
- To avoid unit power cord damage, please do not strain the AC power cable and do not bundle it.



- In order to avoid damages, please ensure that the power cord is not stepped on or pinched by heavy objects.

CE CONFORMITY

- The product is in compliance with Directive 2014/35/UE (LVD) as stated in EN 60950 standard.
- PROEL S.p.A hereby, declares that this product complies with the essential requirements and other relevant provisions of Directive 2014/30/UE (EMC), as stated in EN 55103-1 (E2) and EN 55103-2 (E2) standards.

WHAT'S IN THE BOX

QUIVER

- N. 1 QUIVER
- N. 1 Mains Adaptor 12V - 2A
- N. 1 USB Lamp.
- N. 1 USB memory key with the following files: user manual, fixture editor program for Windows PC, fixture files.

QUIVERX

- N. 1 QUIVERX
- N. 1 CAT5 UTP cable (1mt)
- N. 1 QUIVER-QUIVERX link plate
- N. 4 MA 3x 12mm screws.



GLOSSARY

Many technical terms, which are familiar to lighting programmers, could be unknown for new users, while other terms used in this manual are referred specifically to the use of this console. We suggest you to read the glossary that follows, in order to introduce you to the technical terms and to the fundamental concepts used in the manual. Even if they would be not immediately clear, certainly they will help you to understand the instructions coming after.

Attribute/Parameter

Single function of a fixture which is controllable via DMX such as: dimmers, pan, tilt, color wheel, gobo wheel, etc.

Button

Element of the LCD display graphical interface to press in order to activate the corresponding function. It differs from the switch which is an actual key of the console.

Controller

Controller Slider and Switch freely configurable as: "Grand master", "Group Master" or Register slider. The Register slider can be configured as "Master intensity", "Master size", "Master speed" or "Cross fade".

Cue

Defines the status of an array of attributes/parameters saved in the SD internal memory: it is often known as 'Scene' or 'Memory'.

Qlist (list of Cues)

An ordered set of cues, in this manual it is also quoted as cue list.

Cue-list timing

A set of values which define the timing behavior between individual cues of the Qlist.

DBO (dead blackout)

Operation that voids (turns at zero) all HTP channels of the console.

Editor

Environment that allows to create and edit cues and palettes. The editor has priority over all playback functions.

Empty

Attribute without an assigned status/value. When you save a cue, only the assigned attributes are saved and the empty attributes are discarded.

Fixture

A generic term for any projector or device controlled through DMX.

Flash

A key that takes to 100% the HTP channel/Dimmer of one or more fixtures.



HTP (highest take precedence)

Method to assign the DMX channel priority: in this case when two cues attempt to control the same attribute/parameter the cue with higher value has the priority, typically assigned to the dimmer channel of a fixture.

LTP (latest take precedence)

Method to assign the DMX channel priority: in this case when two cues attempt to control the same attribute/parameter the value of the latest cue has the priority, typically all parameter of a fixture except the dimmer.

Page

Set of 12 console Registers arranged to 12 cue list. The console manages 12 pages of 12 registers to get a total amount of 144 cue list.

Current Page

It is the page currently associated to 12 console Registers. The current page is shown in the status bar in the top left of the LCD display. Only the registers of the current page can be executed. If the expansions are connected the registers that can be executed increase to 24 or 36.

Palette

Status of one or more attributes related to one or more fixtures, to be conveniently used for creating cues and saved in the SD internal memory. Updating a palette automatically upgrades all cues involved.

Playback

Set of console operations that allows to play one or more cue-list: 'Qlist', 'Chase', 'Sequence', 'Live' and associated register switches are all playback operations.

Parameter

See attribute.

Register

Each register is made up of a switch that allows to manage the cue list, mainly to play it but also to save it and modify it. Only the cue lists contained in the current page can be played.

Current Register

All the register operations are referred to the current register if otherwise specified. The current register is shown in the status bar at the left top of the LCD display.

Show

In this case a lighting show controlled by our DMX console.

Slider

Controller made up of a potentiometer with linear cursor. The console is equipped with 6 configurable sliders.

Snapshot

Copy of the status of all DMX outputs: the instantaneous values of all DMX channels are stored in a suitable portion of the memory.

**Switch**

True physical interface button, see further EDIT, REGISTERS, CONTROLLER chapters.

Trigger

Event which determines the activation of a cue, typically the pressing of a register switch.



INTRODUCTION

This manual is organized in 4 sections: the “QUICK GUIDE”, the “REFERENCE MANUAL”, the “QUIVERX MANUAL” and a brief explanation about the Fixture Editor for Windows.

In the “QUICK GUIDE” there is a product’s overview that allows the user to be immediately operative and to use the console’s basic features.

The “REFERENCE MANUAL” explains in detail all the console’s features and operations.

The “QUIVERX MANUAL” illustrates the expansion and its use.

Before starting to use the console we suggest to read completely the QUICK GUIDE and the other sections of the manual.

QUICK GUIDE

Console Overview

Front Panel

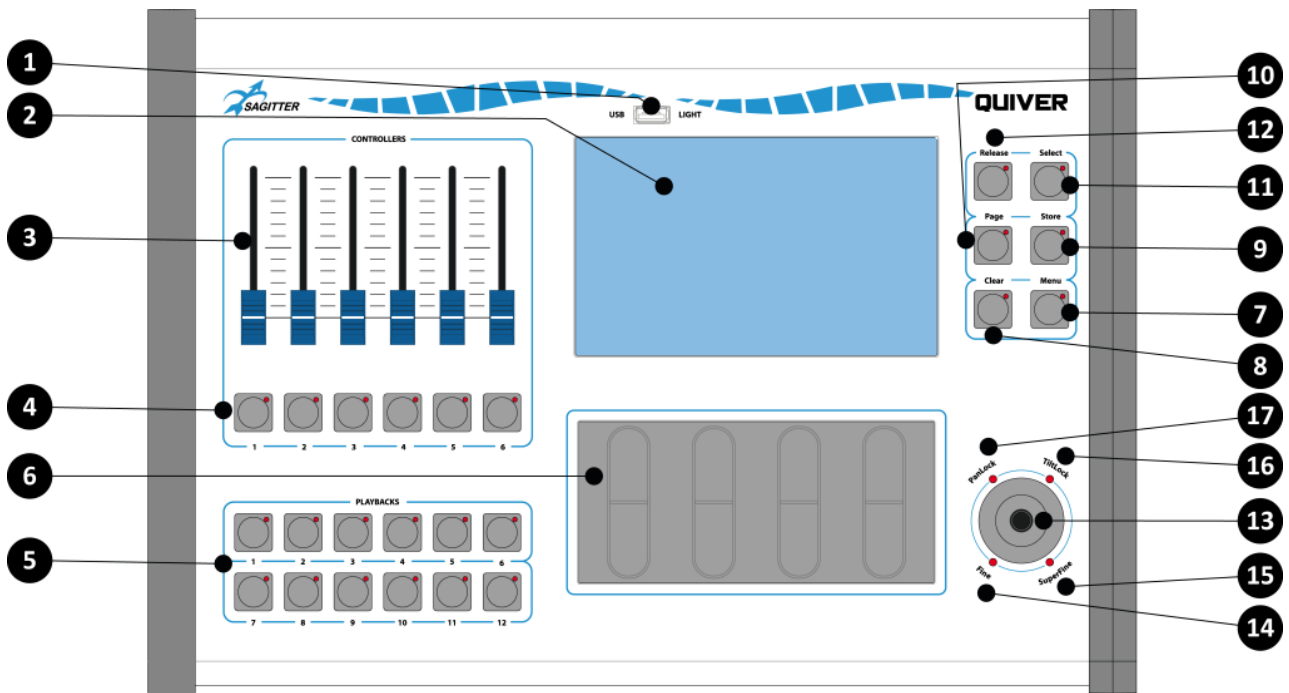

Rear Panel

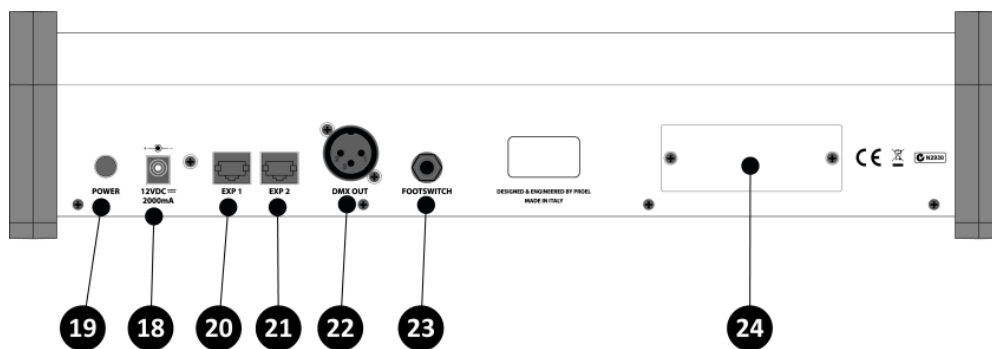

Description

1. USB port to exchange data through USB memory and/or port for USB light.
2. Color LCD with touch screen: graphic interface of the console.
3. Programmable Controller Sliders.
4. Programmable Controller Switches.
5. Register Switches.
6. Touch Sliders for the fixture parameters editing.
7. 'Menu' edit switch.
8. 'Clear' edit switch.

9. 'Store' edit switch.
10. 'Page' edit switch.
11. 'Select' edit switch.
12. 'Release' edit switch.
13. Joystick for pan & tilt.
14. 'Fine' joystick indicator.
15. 'Superfine' joystick indicator.
16. Pan joystick locked indicator.
17. Tilt joystick locked indicator.
18. 12Vdc supply input.
19. Power on switch.
20. RJ45 socket for expansion 1 connection.
21. RJ45 socket for expansion 2 connection.
22. DMX output connector (universe 1).
23. Dual pedal input Jack.
24. Wireless module slot (optional).

Dimensions

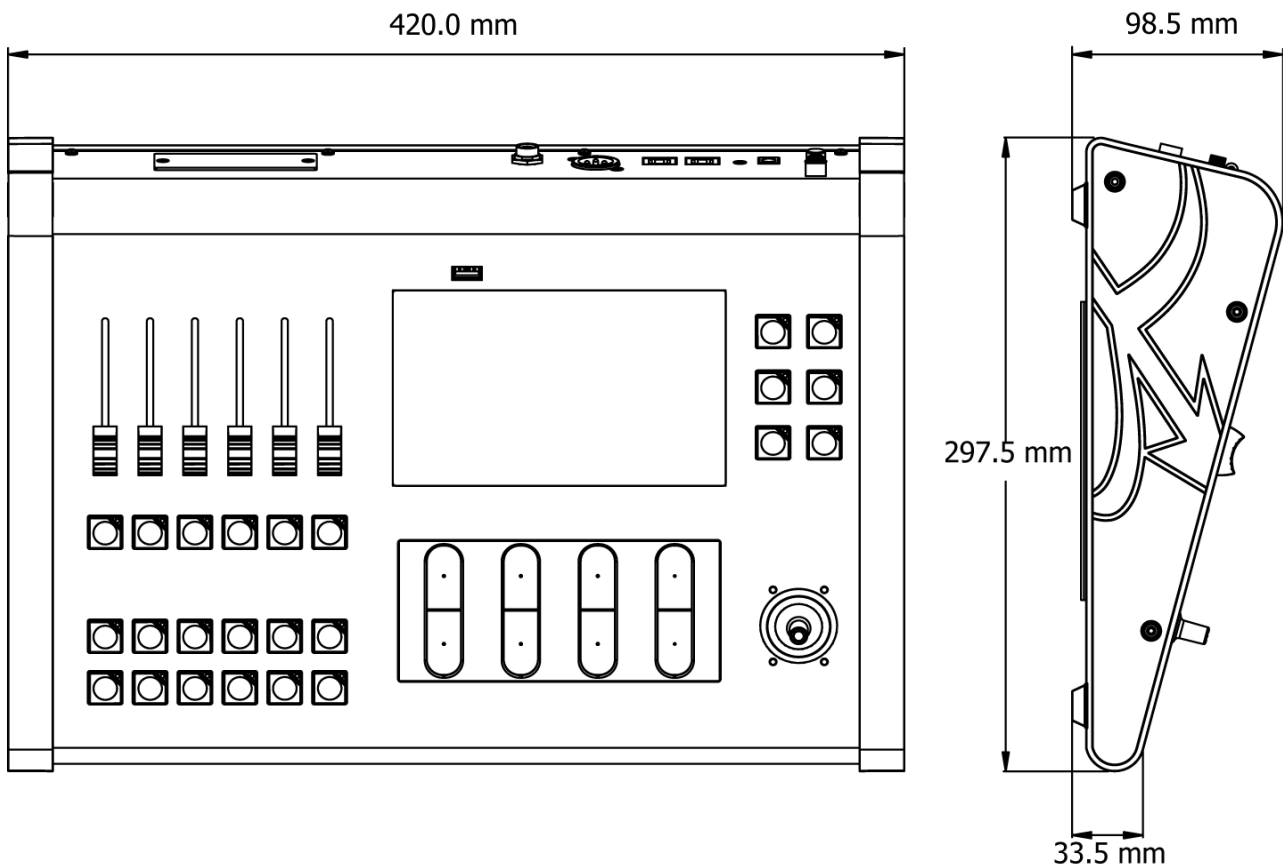



Technical Specifications

Hardware:

DMX universes	1 (max 3 with two expansions)
DMX max channel number	512 (max 1536 with two expansions)
Display type	Color 7" LCD-TFT
Touch screen type	Resistive
Display Resolution	800x480 pixel
EDIT control	6: Menu, Clear, Store, Page, Select, Release
Joystick control	1
Joystick mode	4: Fine, SuperFine, PanLock, TiltLock
Touch Slider	4
Register Switch	12
Programmable Slider	6
Programmable Switch	6
Dual Pedal Input	1
USB host port	1
DMX connector	1 male XLR 3 poles
Expansion Connector	2 RJ45 8 poles
Supply	12 Vdc - 2 A use only supplied AC/DC adaptor

Software:

Fixture type max number	64
Fixture max number	200
Groups max number	50
User Palette max number	999
Cue-list max number	144 on 12 pages
Pages max number	12
Cue max number for cue-list	None (limited by the SD internal memory)
Cue-list max number playable	12 (max 36 with expansions)

The Edit Keys

Release

Allows to stop the playback of a register:

- to stop only one register press Release key + Register switch;
- to stop all registers quickly press two times the Release Key.

Select

Allows to select or to scroll between the registers of the current page:

- To select the current register press **Select + Register switch**: pressing the Select key, its LED goes on and, at the same time, the Register LED goes on; if within 3 seconds another Register switch is pressed, this turns into the current Register.
- Pressing quickly two times the Select key, the next Register is selected.

Page

Allows to select or to scroll between the register pages:

- Press **Page + Register switch** correspondent to the page desired: pressing the Page key its LED goes on and, at the same time, the LED corresponding to the current page goes on; if within 3 seconds another register switch is pressed, this turns into the current page.
- Pressing quickly two times the Page key, the next Page is selected.

Store

Activates the "Store" menu: From this menu it's possible:

- to save the editor contents into a Cue or into a Palette
- to save a "Snapshot" of the console DMX outputs
- to save the selected fixtures as a group.

Quickly pressing two times the Store switch the editor contents is saved as a new cue queued into the current register.

Clear

When it is pressed one time only: all parameters of the selected fixtures in the EDITOR are set as Empty (not assigned).

When it is pressed quickly two times: all parameters of all fixtures in the Show are set as Empty ('Clear all' operation).

Menu

This switch has a double function:

- With a short pressure, it changes cyclically the Joystick control between "Normal", "Fine" and "SuperFine".
- With a long pressure it opens or closes the contextual "Menu".

Register keys

When you press a Register key, it activates the first cue on the cue-list contained in the playback. Each following pressure activates the next cue. If the cue list was already active, when you press the register key it becomes the current register playback.

It can be used in conjunction with the Release, Select, Page and Bank keys (see Edit Keys section).

It's possible to assign to the first 6 registers the 6 console sliders: registers from 7 to 12 are always made up from a single key.

Controller Sliders and Switches

These switches and sliders can be configured via the "Controller config" window from the "Setup" menu into:

- Group master: in this way the slider controls the dimmer intensity (HTP) of the group, while the switch enforces the Flash function of the group.
- Grand master: in this way the slider controls the dimmer intensity (HTP) of all fixtures, while the switch enforces the DBO (dead black out) function.
- Playback master: in this way the slider is reserved to the correspondent register (slider 1 at register 1, slider 2 at register 2 and so on). From the contextual menu of Qlist window the slider can be configured as 'Master intensity', 'Master size', 'Master Speed' or 'Cross fade'.

Touch Sliders

The Touch Sliders allow to modify the values shown in the LCD display on the four buttons just above them. Laying a finger on the Touch Slider the value starts to change and continues to increase or decrease until the finger remains on the slider. The variation speed depends on the finger position: with the finger placed near the center the variation is slower, with the finger placed at the ends the variation is faster.

The Touch Sliders can be used also as step up and step down buttons with two levels: hitting quickly at the ends the value will increase or decrease at bigger steps, hitting quickly near the center the value will increase or decrease at finer steps.

The variation's speed also depends on the joystick state: 'Normal', 'Fine' e 'Super Fine'.

Pan & Tilt aiming

The joystick is always linked to the pan and tilt parameters of the selected fixtures in the EDITOR. As the joystick is moved from the central position, the fixtures start to move and they go on moving until the joystick is released. The motion's speed depends on the joystick position (farther is the position from the center, greater is the fixture speed) and from the state ('Normal', 'Fine' or 'Super Fine').

Console Setup

Before starting to operate the console you must:

- Connect the supply adaptor at the mains outlet.
- Connect the expansions if available (they can be connected or disconnected also with the console switched on)
- Connect the DMX cable to the fixtures.
- Turn on the console with the power switch.

Produce a Show

Add fixtures in the library

To program a show you need first to have available a library of fixtures that form your lighting equipment. The fixtures can be loaded into the console from the SD internal memory or from the USB memory. The supplied USB memory key already contains a series fixtures, in the formats compatible with the QUIVER, for products from the main brands as well as, of course, for the SAGITTER products available at the moment of the console making. These fixtures and any other contained in the USB memory can be copied in the SD internal memory and vice versa. The maintenance operations (add, erase, etc.) are made through the 'Library manager' window in the 'Setup' menu.

The fixture for SAGITTER products can be also downloaded from the web site www.sagitter.com. Finally, custom fixtures can be created using the Fixture Editor software for Microsoft Windows, contained in the supplied USB memory or downloadable from the SAGITTER web site. The Fixture Editor is capable to load and save files in its own native format **.pf**.

The console is capable to recognize the fixtures in its own file format **.pf** and in the Pilot 3000 ascii file format **.fxr**.

Library manager window:



IMPORTANT

In order to be read by the console, the fixtures saved in the USB memory must be arranged in the following way:



- **The root folder in the USB memory must contain a folder named “LIB”;**
- **The LIB folders must contain the brands’ folders.**
- **Each brand’s folder must contain the library files in .pf or .fxr format.**

For example, a file named ‘Club Spot 150 ch14.pf’ for the Sagitter fixture must be saved in the USB memory with the following path (presuming that the computer sees the USB memory as drive G):
‘G:\LIB\Sagitter\Club Spot 150 ch14.pf’.

Address Patch: fixture assignment

Before starting to program the cues it is essential to provide to the console the list of the connected fixtures and their DMX address (also called start address). This information is managed through the “Address patch list” window from the ‘Setup’ menu. Press the ‘Menu’ switch, press the ‘Setup’ button on the LCD display, and then press the ‘Address Patch’ button to display the “Address patch list” window, which shows all the fixtures added to your show.

The view of the fixtures in the “Address patch list” window follows the increasing order of the ID number assigned automatically or set up manually: the number to the side are the DMX universe and address.

Setup Menu:

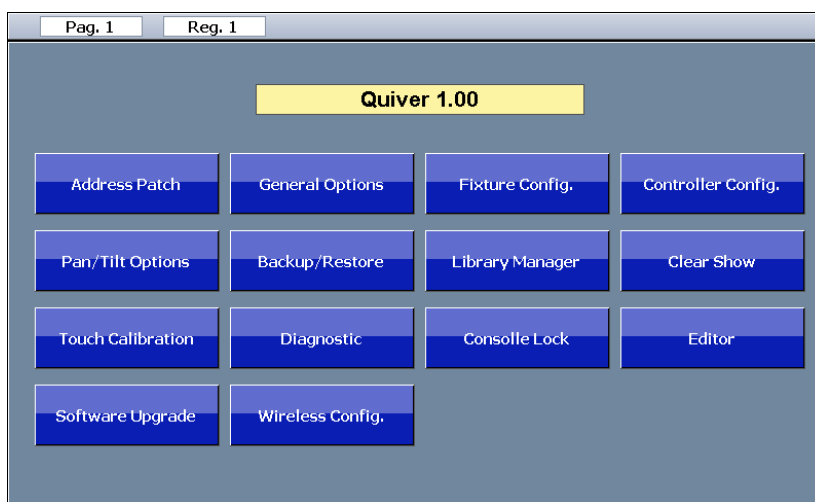

Address patch list window:



Pressing the 'Fixture browser' button you can access the library (that can be located whether in the SD internal memory or in the USB memory) and add the fixtures desired to the patch of the show.

Fixture Browser window:

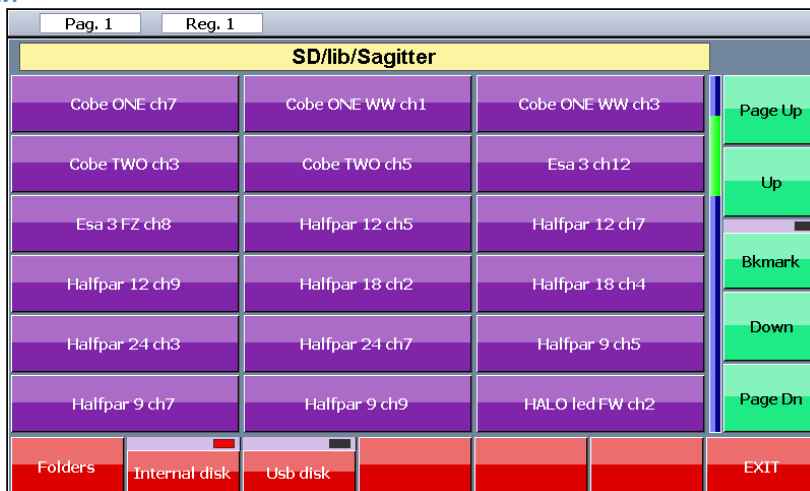

Pressing the button of the desired fixture the "Add fixture" window appears, that allows to set up the number of fixtures of the selected type to be added at the show.

Using the lower buttons, it's possible to specify the number of fixtures, the ID, the universe and the start address of the first fixture. Pressing the 'Add fixtures' button the specified fixtures is added to the show with consecutive DMX addresses.

IMPORTANT: when a fixture is added to the patch, the set up information of the fixture are copied into the show data. Any following modification or cancellation of the library files will not have influence over the operation of the show.

NOTE: the DMX universes 2 and 3 are available only with the expansions connected.

Add Fixtures window:

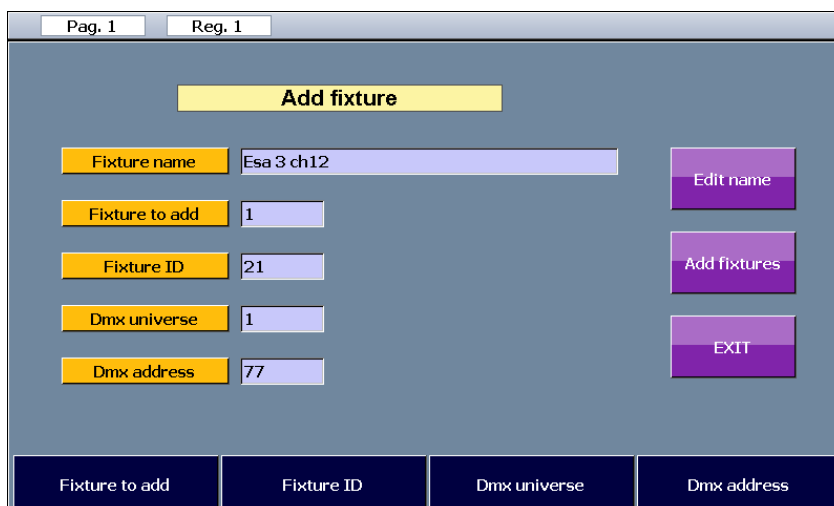

Editor

The “Editor” screen is the main window to be used to program the show. Through this window you control the parameters of the fixtures, allowing the creation of cues and palettes.

The console manages up to 144 cue-list for each show (arranged in 12 pages) and up to 990 palettes.

The fixtures’ parameters are set by means of the Touch Sliders and the joystick (the joystick always controls the pan and tilt of the selected fixtures).

Editor in fixture view:



Editor in Group view:



The fixture can be selected one by one using of the correspondent buttons or together using the ‘Group’ way: you can switch alternately from the fixture view to the group view using the Fixture/Group button. Pressing the ‘Intensity’, ‘Pan Tilt’, ‘Colors’, ‘Gobos’, ‘Prism’ and ‘Blade’ buttons the parameters of the selected fixtures are assigned to the 4 Touch Sliders.

To set the attribute values using the palettes, select the fixtures, move to the palette window pressing the ‘Palette’ or ‘Cmy pal’ buttons, then select the chosen palette pressing the correspondent button.

Each fixture’s and group’s button has two LEDs.



The LED on the left can be:

- Off: The EDITOR doesn't control the parameters of the fixture or group.
- Yellow: one or more attributes of the fixture or group are controlled by the EDITOR.
- Green: all parameters of the fixture (or all the parameters of the group's fixtures) are controlled by the EDITOR.

The LED on the right show the selection state:

- Off: the fixture or the group is not selected.
- Red: the fixture or the group is selected.
- Yellow: some fixtures belonging the groups are selected (valid only for the groups).

The 'Locate' button sets the selected fixtures in the 'locate' position, assigning a nominal value to all the fixture' parameters (typically open dimmer, pan and tilt at 50%, etc.).

The 'Hilite' button opens temporarily the shutter and sets the dimmer at 100% for the selected fixture, without inserting the correspondent values in the EDITOR. It is a useful function that allows to create cues or palettes leaving the shutter and dimmer values as 'Empty', for example aiming the pan and tilt.

IMPORTANT: typically, the programming of a cue begins setting all fixtures involved in 'Locate' state. In an advanced use of the console could be necessary to program the cue leaving one or more parameter values in the 'Empty' state.

Save a Cue/Group/Palette/Snapshot

When a scene is ready to be saved press the 'Store' switch and the LCD display will show the save menu with the following options:

- Save the EDITOR contents as a new palette ('Intensity', 'Pan/tilt', 'Color', 'Gobo', 'Prism' and 'Blade' buttons).
- Save the EDITOR contents as a new cue and queue it in the current register ('Cue' button).
- Save the DMX outputs in a new cue and queue it in the current register ('Snapshot' button).
- Save the selected fixtures as a new group ('Group' button).

Modify a cue

Pressing the 'Qlist' button in the EDITOR window, the current cue-list window appears on the display. To modify a cue you have first to load it in the EDITOR: select the cue to modify (the right LED turns red), press the 'Load cue' button from the contextual menu. After you have modified the cue just press the 'Update' button from the contextual EDITOR menu.

Palette

The palettes are preset memories that allows to speed up the programming. It is very useful to arrange some pan-tilt palettes so that the aiming of the fixtures can be done very easily selecting the desired fixture and then choosing the palette related to the position desired.

IMPORTANT: when a palette is modified, all cues that are related with it acquire the new values. This is particularly convenient in case of itinerant shows, where on each date the light positions need to be corrected.



Inside every show there are some palettes already stored: these are the palettes in the library files and the color palettes usable by the fixtures with RGB or CMY color mixing systems. Besides these pre-set palettes, you can create your own customizable palettes (up to a maximum of 999 palettes per show). The current set of CMY can be chosen between *Chris*, *Gam Lee*, *Rosco* (in the 'General options' window from the 'Setup' menu).

To apply a palette to the selected fixtures you have to press the 'Palette' button to show the palette window and select the desired palette.

The user palettes are organized in six different sets: Intensity, Pan/tilt, Colors, Gobos, Prism, and Blade buttons allow to show the corresponding palette set.

To create a new palette you have to set up the fixture in the show at the desired values, then save it pressing one of the Intensity, Pan/tilt, Colors, Gobos, Prism, and Blade buttons in the 'Store' menu. When a palette has been saved, only the correspondent parameters are stored (as example saving a palette of Pan/Tilt type only the Pan/Tilt parameters are stored and all others are ignored).

Playing – cue execution

The cue-lists are arranged in 12 pages, each one containing 12 cue-lists. The registers allow to interact with the cue list of the current page. By pressing a Register's switch, the first cue of the cue-list linked to the Register is activated (example: pressing the key of Register 3 it plays the first cue of the cue-list 3 of the current page). With the expansions it's possible to play also the cue-list of the following pages, from the current to a maximum of 36 cue-lists.

Pressing again a Register key, the next cue is activated, and so on until the latest cue is reached, then restarting from the first one. It is possible to associate to the first 6 registers a slider to control the master Intensity or the master size or the master speed of the cue-list. Without a physical slider all other masters are fixed to 100%.

IMPORTANT: *the EDITOR view has the priority over the registers, therefore a cue-list is not capable to take the control of the channels controlled by the EDITOR. Typically, before starting to play the cue-list it is recommended to make a clear-all of the EDITOR (quick double pressing of 'Clear' switch).*

When two cues fitted in two different registers challenge the same DMX channel, the following criterion is applied:

- If the channel is set as LTP, the priority is for the cue played most recently.
- If the channel is set as HTP, the criterion LTP o HTP is applied (priority at the higher value) as specified in the field 'Playback mode' in the 'General options'.

To turn off a cue-list you must press the 'Release' key and then quickly the register key or press the register key while the 'Release' key is pressed. Pressing quickly two times the release key all register stop playing (function 'Release all').

If you change the page, a new 12 cue-list set completely independent from the previous is associated to the console 12 registers. To make the transition more 'gentle', the page changing doesn't stop the registers currently playing: after the page change, the active registers continue to control the cue-list of the previous page and only after the release the new cue-list will be associated. Be careful because in this situation it could happen that cue lists of different pages are playing simultaneously.

REFERENCE MANUAL

This section of the manual describes in detail all the console's operative environments.

EDITOR

EDITOR is the main environment for starting to program the show.

Fixture mode

The editor allows to set and edit the values of all the fixtures' parameters and to save them as cues or palettes. The editor includes various windows and displays: when the console is switched on, the editor is in fixture mode.

EDITOR in Fixture mode display:

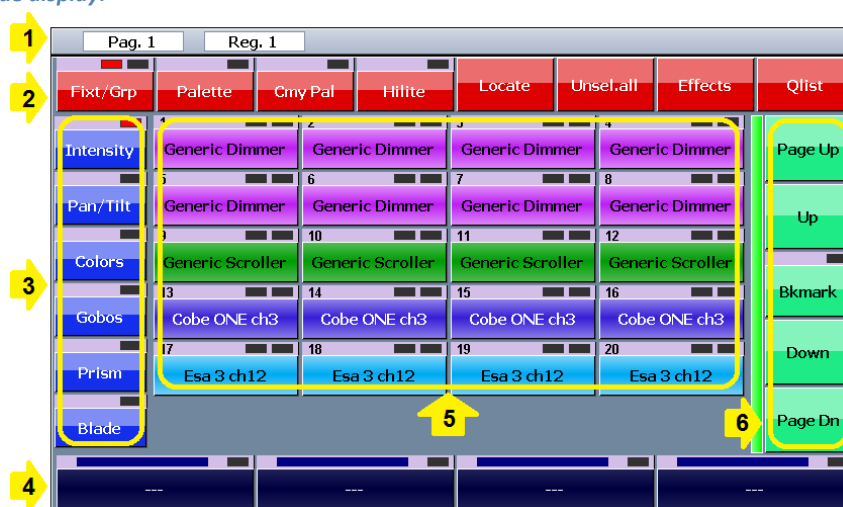

Legend:

- 1) *Status bar*
- 2) *Command Toolbar*
- 3) *Parameters Toolbar*
- 4) *Touch Slider Toolbar*
- 5) *Fixture list*
- 6) *Scroll bar*

Elements of fixture mode:

1. Status bar

Shows the current register (on the right) and the current page (on the left).

2. Command Toolbar

- **Fixt/Grp**: switches between Fixture display and Group display, the LED over the button indicates the active display.
- **Palette**: recalls the user palette display.
- **Cmy Pal**: Recalls the *Chris, Gam, Lee, Rosco palette window*, which is set from 'Rgb/Cmy palette set' option in the 'General options' display.

- **Hilite**: when 'Hilite' is active, the 'Hilite' palette is applied to the selected fixture, which temporarily opens the shutter and sets the dimmer at 100% without inserting the correspondent values in the EDITOR. It is a useful function to create cues or palettes leaving the shutter and dimmer values as 'Empty', for example for aiming the pan and tilt.
- **Locate**: applies the locate palette to the selected fixtures, which assigns a nominal value to all the fixture's parameters. Typically, this command is used before starting to program the cues.
- **Unsel all**: deselects all selected fixtures.
- **Effects**: opens the Effects' window.
- **Qlist**: opens the cue-list view for the current register.

3. Parameters Toolbar

Pressing one of these buttons, the top 4 parameters of the corresponding set are displayed and can be edited by the Touch Sliders. If the selected set has more than 4 parameters, press the button again to scroll through them all, 4 at a time.

The LED over the button shows the current selected set of parameters.

4. Touch Sliders Toolbar

These buttons show which parameter is assigned to each Touch Slider: acting on the Touch Slider is possible to change the parameter value for all selected fixtures.

Pressing the button a virtual numeric keypad appears that allows to input directly the number for the parameter or to take back the parameter at the 'Empty' state using the 'Free' button.

The elements that form the Touch Sliders' buttons are:

a) LED of channel state:

- Off: all parameters linked to the Touch Slider are 'Empty'.
- Red: all parameters linked to the Touch Slider are controlled by the editor.
- Yellow: only some parameters linked to the Touch Slider are controlled by the editor.

b) Analog view of the parameter value.

c) Name of the parameter and its numeric value. If the parameter value is the value stored in a palette, then the palette name is shown. When the parameters assigned to the button have different values, then three asterisks are shown.

5. Fixture List

Each one of these buttons corresponds to a fixture of the show: pressing the button alternatively it selects or deselect the correspondent fixture. The elements that form the buttons are:

a) Fixture ID: ID number of the fixture that puts in order the button view. They can be also not consecutive numbers and they vary from 1 to 9999.

b) Status LED of the fixture channels:

- Off: all parameters of the fixture are 'Empty'.
- Red: all parameters of the fixture are controlled by the editor.
- Yellow: some parameters of the fixture are controlled by the editor.

c) Selection LED of the fixture:

- Off: the fixture is not selected.

- Red: the fixture is selected.
- d) Name of the fixture: name assigned to the fixture by the user.
- e) Button background color: it can be changed as you wish for an immediate identification of fixture types and groups.

6. Scroll bar

The scroll bar buttons allow the scrolling of the elements in the window. The scroll bar is also provided with a Bookmark button, which is used to move quickly to an exact location on the list. If you press and hold the Bookmark button for few seconds, the current position is saved and the button's LED is on. Each time you press the Bookmark button, the list gets to the stored position.

Fixture Mode Contextual Menu

Fixture Contextual Menu Window:

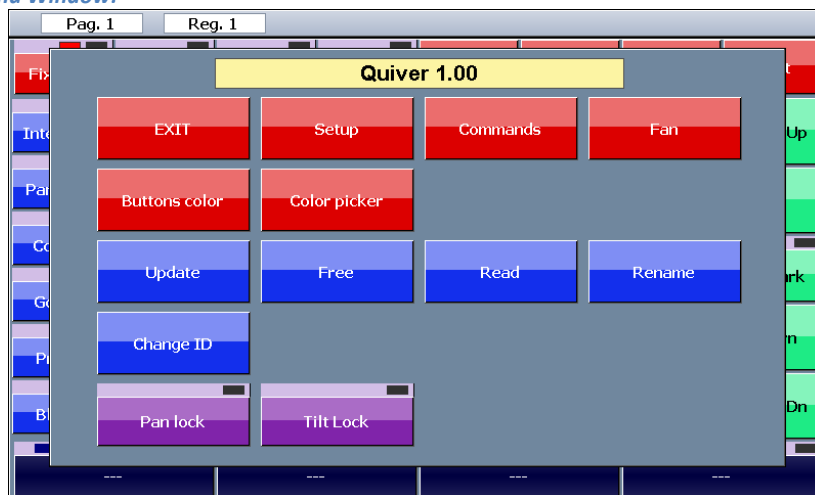

The EDITOR contextual menu has the following buttons:

- **EXIT:** closes the contextual menu.
- **Setup:** opens the setup menu.
- **Commands:** opens the 'Commands' window to send specific commands (as reset, lamp on, lamp off, etc.) to the selected fixtures.
- **Fan:** opens the fan window that allows to set up the parameters of the selected fixtures following a fan evolution.
- **Buttons color:** allows to change the color of the selected buttons.
- **Color picker:** allows to set up the color of the selected fixtures using a color table. Obviously, it can be used only for fixtures equipped with RGB or CMY color mixing system.
- **Update:** updates and saves in the SD internal memory the cue or palette previously loaded in the editor from a cue-list.
- **Free:** sets as 'Empty' all parameters of the selected fixtures.
- **Read:** picks up the values of the DMX outputs and copies them into the parameters of the selected fixtures in the editor. The use of the 'read' command could be the following: while some cues are playing and you note that some fixture creates a light scene that can be used for future programming, then from the editor you can select those fixtures and use the 'read' command to copy their parameters in the editor.
- **Rename:** allows to change the fixture's name.



- **Change ID:** allows to change the fixture's ID number.
- **Pan lock:** locks or unlocks the pan control of the joystick for the moving fixtures.
- **Tilt lock:** locks or unlocks the tilt control of the joystick for the moving fixtures.

Group Mode

The groups window is identical, in both form and features, to the fixtures window, except for the fact that the selection is made by groups. By pressing a group button, all the fixtures therein can be alternately selected and de-selected. The organization of the fixtures into groups is particularly useful when a show includes many fixtures and they are often managed together.

As for the fixtures, each group button has the same elements that mark out the fixture buttons: ID, Status LED, Selection LED, background color and group name. In this case the selection LED can assume also the yellow color to show that only some fixtures of the group have been selected.

The group's contextual menu has the same options of the fixture's contextual menu plus the 'Delete group' button that allows to remove the selected group.

Create or modify a group

To create a new group select the fixture and then press the 'Store' switch and the 'Group' button from the menu on the display. If a group with the same name is already present, it's overwritten and replaced.

There isn't a specific command to modify a group, but you can proceed as for the creation of a new group using the same name of the group to be replaced.

Palette

Palettes are pre-set memories that speed up the programming. Each fixture usually already has some pre-defined palettes in the .pf file, but the user can create new custom ones.

The preparation of pan-tilt palettes can be very useful: once the preparation of the palettes is complete, the pointing of the fixtures is done simply by selecting the desired fixtures and then clicking on the palette of the desired location (for example pianist, guitarist, drummer etc.).

IMPORTANT: *when programming the cue with the palettes, the reference to the palette is saved into the cue. Consequently, any palette's modification is applied automatically to all the cues that refer to it. This method is particularly useful to make position's amendments on previously programmed shows.*

The palettes are divided into 6 types according to the parameter's families (Intensity, Pan/Tilt, Colors, Gobos, Prism and Blade). If one or more fixtures are selected, the palette window shows only the palettes available for all the fixtures selected in the current family. If no fixture is selected, then all the palettes in the current family's show will be displayed.

User palette window:

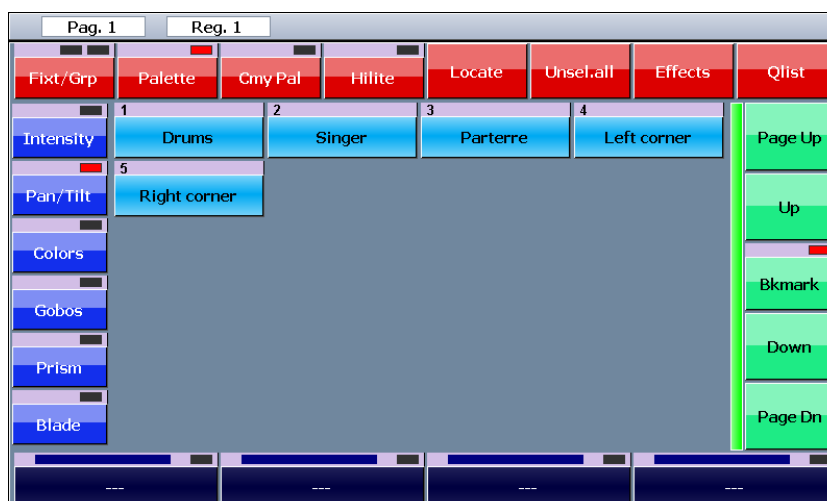

Palette mode contextual Menu

This menu, in addition to all command of the fixture contextual menu, contains the following buttons:

- **Load Palette:** this button loads in the editor the last palette played from the palette window, for checking or modifying it. Any change of a palette will have effect on all cues that refer to it. To save the palette in the same position always use the 'Menu' switch instead of 'Load Palette' button, so the '**Update**' button will appear.
- **Rename:** allows to change the name of the last palette played from the palette window.
- **Delete:** allows to erase the last palette played from the palette window.

IMPORTANT: a palette can be deleted only if no cue are using it. This is to prevent that some parameters become undefined. Change ID and Rename are allowed because they don't affect a cue.

Create a new palette

To create a palette after having set the fixture's parameters press the 'Store' switch, then one of the buttons 'Intensity', 'Pan-Tilt', 'Color', 'Gobo', 'Prism' or 'Blade', depending on the parameters to be stored for the palette (only one type of parameter can be saved). Finally, give a name to the new palette and confirm with 'Enter'.

Edit an existing palette

To edit an existing palette, proceed as follows:

- 1) Select the palette by pressing the corresponding button.
- 2) Press the 'Load' button from the contextual menu (the 'Load' button loads the last palette used into the editor).
- 3) By using the features of the editor, apply the changes needed.
- 4) Finally, press the 'Update' button from the contextual menu to replace the old palette with the new values.

IMPORTANT: if you edit a palette, all the cues referring to this palette will consequently be modified.

Saving with the 'Store' key a palette with the same name of an already existing one results in the generation of a new palette with the same name. Although it's allowed, you are advised that this can generate confusion.

Color Palette

The console is provided with four colors' preset (Chris, Gam, Lee and Rosco) that can be used with fixtures fitted with RGB or CMY color mixing system. Pressing the 'Cmy Pal' button in the upper toolbar the display shows the current set of color palette. The preset palettes can be used in the same way as the user palettes, but they cannot be modified.

The list of palette presets can be set in the 'Rgb/Cmy palette set' box in the 'General options' window from 'Setup' menu.

Effects

An effect is a pre-defined evolution of a value which is repeated in a cycle of time and which can be applied to any parameter of one or more fixtures simultaneously. Speed, amplitude, period and phase can be edited by the operator to obtain an organized time evolution of the fixtures (for example, the circular movement for pan and tilt of moving heads or various 'pulses' applied to the dimmers of a group of fixture).

Effect window

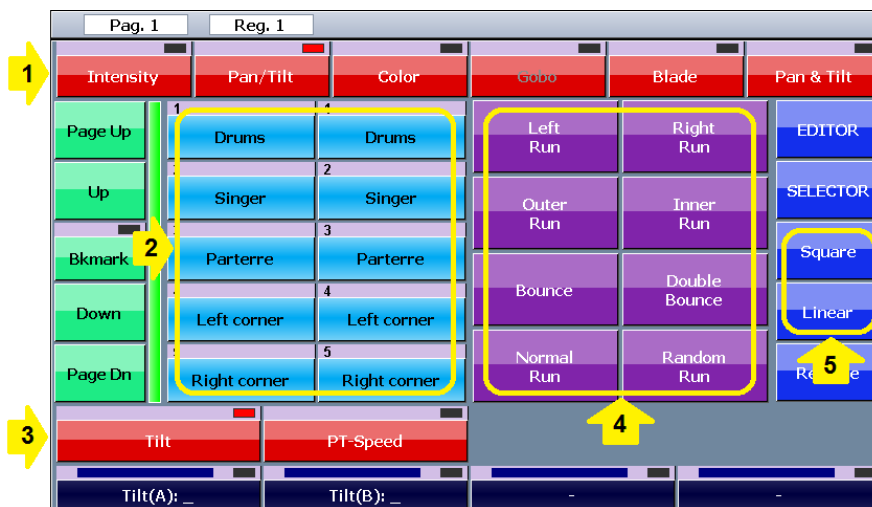

Legend:

1,3) Parameter Selection

2) User Palette

4) Phase

5) Wave Shape

The effect windows allows to program a simultaneous effect for pan and tilt or a single effect for independent channels (ex. dimmer).

Effect window for pan and tilt:



To apply an effect to an attribute of the previously selected fixtures, proceed as follows:

- 1) In the editor select the desired fixtures.
 - 2) Press 'Effects' button in the upper toolbar.
 - 3) Select the parameter where the effect as to be applied, pressing one of the buttons on the toolbars 1 and 3.
 - 4) Select the minimum and maximum values of the wave-form by clicking on the palette buttons or operating on the first two Touch Sliders.
 - 5) With the linear and square buttons, it is possible to select the wave-form (respectively sinusoid and square wave).
 - 6) The third Touch Slider (Period) enables to vary the speed of the effect.
 - 7) With the Phase buttons and the fourth Touch Slider the global effect can be adjusted.
- These settings are effective only if the effects involve two or more fixtures.

In case of simultaneous Pan e Tilt ('Pan+Tilt') the window is slightly different: instead of the phase buttons there are the path buttons and the 'Left/Right' e 'Sync/No Sync' buttons, that allow to obtain an effect similar to a chase.

Saving an effect as cue

A parameter containing an effect, although its value changes in time, can be saved in a cue. The cue is saved using the 'Store' key and 'Cue' button or as explained in 'The Edit keys' paragraph at 'Store' item.

IMPORTANT: *an effect cannot be saved in a palette.*

Edit an existing effect

To edit an effect which had previously been saved in a cue, load the cue into the editor, select the fixtures involved and finally open the window of the effects generator to edit. If the show contains many fixtures with effect or if one cue contains more groups of fixtures with different effects, selecting the fixtures may be a difficult task. In this case, the Selector window helps to analyze the content of the cue and recreates the groups of fixtures that have the same effect.

Press the 'Selector' button when you are in the effects window to open the Selector window. In the upper buttons, the number of effects present in the cue is shown for each family of attributes (for example, in the picture there is a cue containing 4 groups of fixtures, two with Intensity

effects and two with Pan/Tilt effects). Pressing one of the upper buttons, the fixture groups with the same effect are selected, pressing again the button you scroll to the next effect. Once the group which contains the effect to be edited has been identified, press OK to go back to the effects window and to modify the effect.

Selector window:

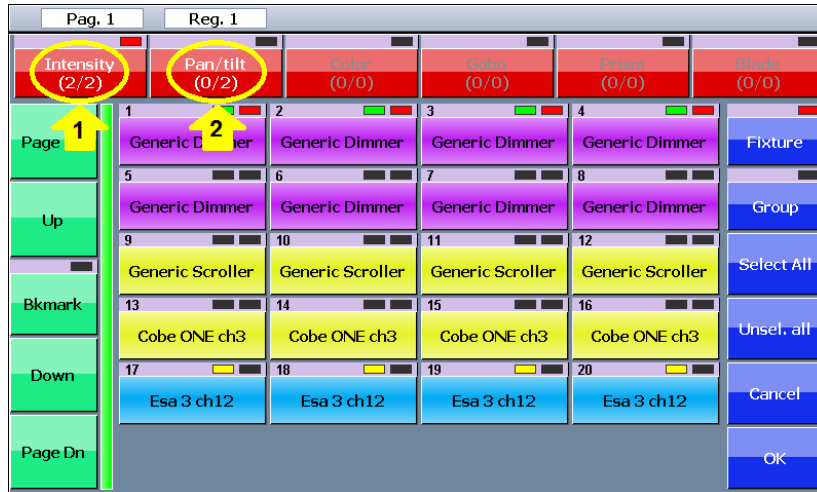

Legend:

- 1) *The second of 2 Intensity effects is selected.*
- 2) *Two effects of Pan and Tilt are present.*

FAN

The fan feature assigns a sequence of values to the same attribute of the selected fixtures. The sequence of values can follow the trend of a ramp or of a semicircle.

'Fan' window:

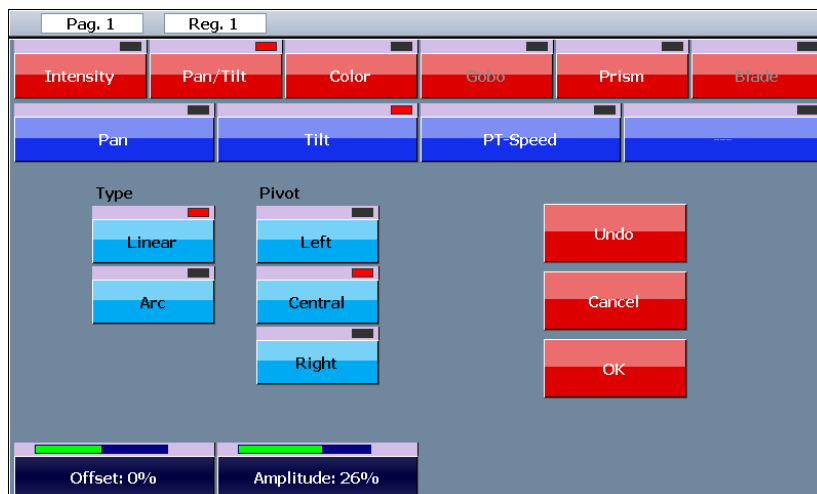

Linear and Arc fan:

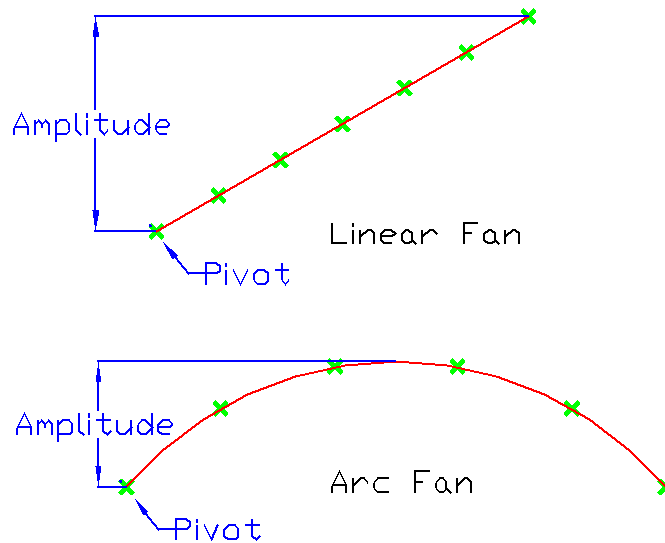

Once having selected all the fixtures involved in the editor, press the Fan button from the contextual menu and the corresponding window will appear. The two series of buttons at the top allow you to select the parameter you wish to edit.

The 'Linear' and 'Arc' buttons allows to select the fan type (as shown above).

The 'Left', 'Central' and 'Right' buttons allows to select the pivot element (the pin that remains fixed at the amplitude variation).

'Amplitude' value can be also negative, 'Offset' value is summed with the editor value to define the pivot position, both are input through the Touch Slider. Increasing or reducing the offset value, all the values of the fixtures involved are increased or reduced in the same way.

When you press the 'OK' button the parameters are moved to the editor and they are ready to be stored in a new cue.

Color Picker

The color picker window is used to change the color of the buttons relating to different types of objects of graphical interface (fixtures, groups, palettes, cues, etc.) and also to set graphically the color for the fixtures provided with RGB or CMY color mixing system.

To change the button's color you have first to select the buttons, then from the contextual menu choose 'Buttons color' button.

To assign a RGB or CMY color mix to the fixtures you have to select them first and then choose the 'Color picker' button from the contextual menu.

Color picker:

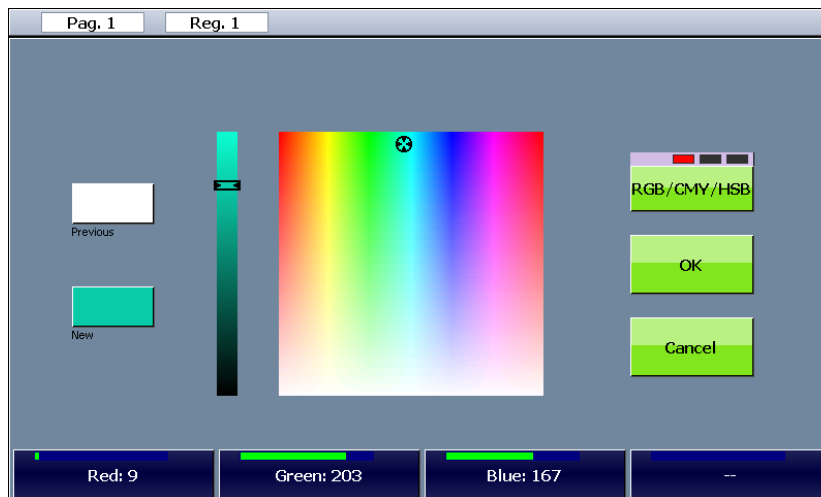

Colors can be selected directly from the color bitmap and luminosity slider on the display or using the first three Touch Slider. The RGB/CMY/HSB button selects the input mode scrolling through the three available color modes (Red / Green / Blue, Cyan / Magenta / Yellow and Hue / Saturation / Brightness).

Playback

Playback is the moment when, after the programming activity has been completed, the show begins and you can play and execute (manually or automatically) the cues stored in the various cue-list.

The console allows the operator to play up to 36 cue-lists at the same time (12 with the console alone, 36 with both expansions connected), chosen between a set of 144 (12 pages with 12 cue-list each).

IMPORTANT: *the editor and 'Hilite' button always have priority on playbacks and controllers, therefore, with the exception of specific cases, the transmission of a show occurs after having set the editor to zero (double click on the 'Clear' key).*

The output values of the fixture parameters depend on the active cues. Regarding the values that are not involved in the active cues:

- for LTP parameters they take the stand-by values if they are defined, otherwise they remain stable to the latest value previously set by a cue;
- for HTP parameters they are set to zero value.

Cue list

A cue list is an ordered set of cues. Each cue includes the condition of some parameter sets for several fixtures and the information about their time evolution. Each cue-list can be configured in four play modes: *Qlist*, *Chase*, *Sequence* or *Live*. Trigger and time tuning are function of the play modes.

Cue-list in Qlist mode:



Legend:

- 1) Buttons for the selection of the cue-list mode
- 2) Activity status LED: yellow=previous active cue; red=currently active cue
- 3) Selection status LED: red=selected cue
- 4) Bar timeline Delay/Fade-in
- 5) Bar timeline wait/fade-out
- 6) Delay time in seconds
- 7) Fade-in time in seconds
- 8) Wait time in seconds
- 9) Fade-out time in seconds

The cue buttons have a status LED:

- *Off*: not activated cue.
- *Yellow*: activated cue.
- *Red*: last or currently activated cue.

The buttons on the left toolbar allow the following operations:

- **EDITOR**: recalls the editor window.
- **Lock**: usually the Qlist window shows the cue-list corresponding to the currently played register and changing the register the display will follow it. If the 'Lock' button is activated the window is locked to the current cue-list and the display will not follow the next pressed registers. This feature is very useful in Live mode.
- **Qlist, Chase, Sequence, Live**: buttons to select the cue-list mode.
- **Unselect all**: deselects all cues.

Touch Sliders in Qlist mode:

- **Touch Sliders**: if no one cue is selected the Touch Sliders allow to vary the master controls of the cue-list: Size (size of amplitude parameter of the effects), Speed (play velocity of the effects) and Master (intensity of light of the effects). The variation is a percentage of the values in the effects. Selecting one or more cues, the four Touch Sliders allow to vary delay, Fade-in, Wait e Fade-out of the selected cues. Pressing the buttons on the screen just above the Touch Sliders, a keypad will appear that allows to input directly the values.

Cue-list in *Qlist mode*

The progression over time of a cue is marked by the trigger and develops on inserted time base: *Delay, Fade-in, Wait and Fade-out*.

The trigger of a cue is typically the pressure of the register key or another type of event on an input port:

- **Delay:** waiting time from trigger event to the effective activation of the cue.
- **Fade-in:** time to start a cue.
- **Wait:** waiting time from trigger event to the fade out.
- **Fade-out:** time to Fade out.

IMPORTANT: *Delay+Fade-in and Wait+Fade-out times define two time lines and they are not in sequence.*

Time progression of a cue which has received a trigger:

- 1) Everything remains stable until *Delay* and *Wait*.
- 2) At the *Delay* stage, the LTP e HTP attributes set at values different from zero start to move towards the final value and they reach it in a time equal to the *Fade-in*.
- 3) At the *Wait* stage, the HTP attributes set at zero or Empty start to move towards zero and they reach it in a time equal to the *Fade-out*.
- 4) At the *Delay+Fade-in* stage, the entrance stage of the cue is completed (all LTP and HTP attributes with values different from zero and not Empty have reached the final value).
- 5) At the *Wait+Fade-out* stage, all the HTP attributes with values different from zero and not Empty have completed the *Fade-out* and they are be at zero value.
- 6) Once the *Fade-in* is completed all outputs remain the same until the following trigger arrives.

Wait and *Fade-out* times are optional: if not inserted, they are considered to be equal to *Delay* and *Fade-out* times.

Time progression of a cue

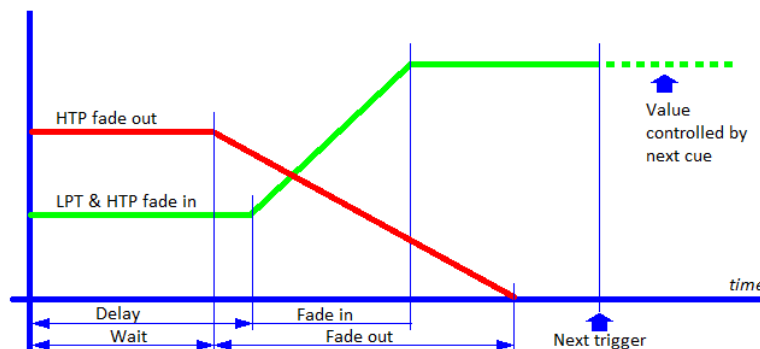

Cue-list in *Chase Mode*

In a cue list configured in Chase mode all cues have a common timing. The playing order of the cues can be selected between 'Forward', 'Reverse', 'Bounce' (forward and reverse) or 'Random' using the button on the left toolbar. The Manual/Auto button allows to choose between the automatic execution of the cues (each cue starts automatically when the previous is completed) or the manual execution (each cue requires a manual trigger to be executed).

Cue-list in Chase Mode:



Touch Slider in Chase Mode:

- **Fade:** time to fade expressed in percentage of the cue total time.
- **Speed:** speed of the cue expressed in beats per minute.
- **Master:** submaster of intensity.

Cue-list in Sequence Mode

In Sequence mode, the cues are automatically activated upon fade-in completion of the previous cue. The delay of a cue is the playing time of the previous cue. The execution order is sequential and cyclic starting from the first to the last and then restarting from the first again.

Cue-list in Sequence mode:



Touch Slider in Sequence Mode:

- **Size:** controls the amplitude of possible effects contained in the cue.
- **Speed:** controls the speed of possible effects contained in the cue.
- **Master:** submaster of intensity of the cue.

IMPORTANT: when a cue-list is played in sequence mode the delay of the first cue is neglected.

In this mode is not possible to input the Wait and Fade-out times that are assumed respectively equal to the Delay and Fade-in times.

Cue-list in *Live mode*

A cue list in Live mode allows you to activate single cues directly from the touchscreen. Pressing a button the corresponding cue is played with the pre-programmed times, allowing to execute the various cues without a prearranged order, but based on the circumstances. To insert the time values in the cues you must switch to Qlist mode, insert or modify the values then go back to Live mode. The 'Lock' button becomes useful to lock the screen on the desired cue-list, ignoring the triggers of other registers.

Cue-list in Live mode:

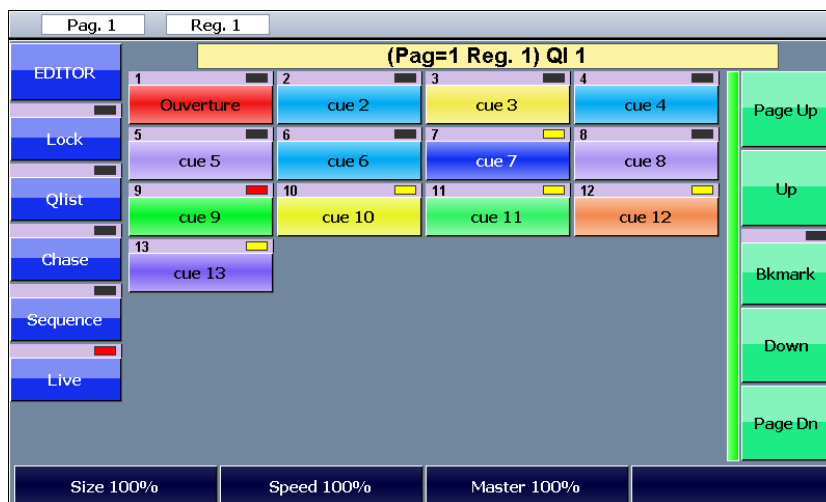

Touch Slider in Live mode:

- **Size:** controls the amplitude of possible effects contained in the cue.
- **Speed:** controls the speed of possible effects contained in the cue.
- **Master:** submaster of intensity of the cue.

IMPORTANT: the Live window is to be considered as an extension of the physical commands of the corresponding playback. When changing page, the Live window will show the cue list corresponding to the new page regardless of the Lock button status. Only if the cue list is active the window will continue to show the same cue list, until this cue list is released.

Cue-list contextual Menu

The four cue list modes (*Qlist*, *Chase*, *Sequence* or *Live*) share the same contextual menu activated pressing the 'Menu' key, that allows the operations explained below: the red buttons recall the general operations while the blue buttons recall the operations of the specific cue-lists.

Cue-list contextual menu window:



The QLIST contextual menu has the following buttons:

- **EXIT:** closes the contextual menu.
- **Setup:** opens the setup menu.
- **Editor:** goes directly to the editor window.
- **Slider config:** opens the slider configuration window (Qlist mode only), see below.
- **Buttons color:** allows to change the color of the selected buttons.
- **Load cue:** allows to load the selected cue in the editor.
- **Rename Qlist:** allows to change the name of the cue-list.
- **Copy Qlist:** makes a copy of the current cue-list in another page/register.
- **Delete Qlist:** deletes permanently the cue-list and its cues.
- **Move Cue:** allows to move a cue of the cue-list to another position (ID changing).
- **Rename Cue:** allows to change the name of a cue.
- **Copy Cue:** makes a copy of the selected cues getting down in line of the cue-list.
- **Delete Cue:** deletes permanently the selected cues.

Register Slider: Playback Master

Configuration window of the 'Register Slider':

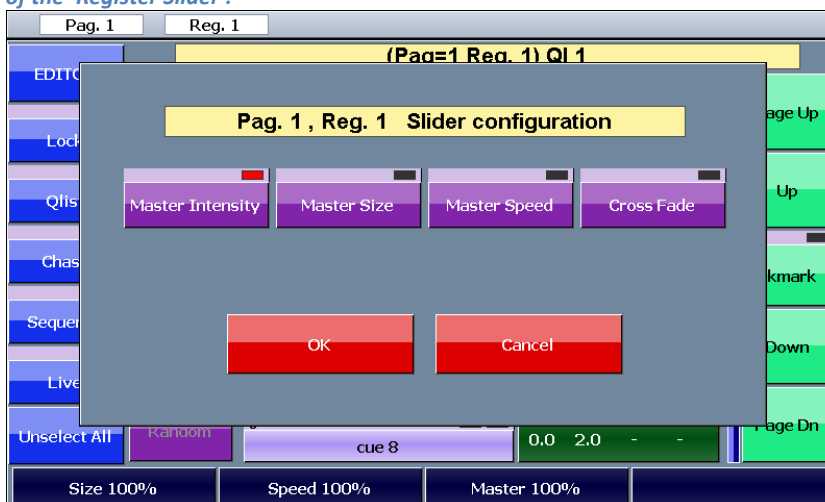



If the Register Slider is set as Playback master ('Controller Config.' window that can be recalled from Setup menu), it can be set independently for each cue-list. From the contextual menu press the 'Slider config.' button to show the slider setup window:

- **Master intensity:** this is the default mode, which is a submaster of the cue-list and controls the HTP channels (typically the dimmer).
- **Master Size:** controls the amplitude of possible effects contained in the cue-list.
- **Master Speed:** controls the speed of possible effects contained in the cue-list (NOTE: it's able to reduce the speed of an effect, but it is not able to increase it).
- **Cross fade:** in this mode the slider steers the transition between a cue and the next one, allowing to manage manually the cross-fade between cues and releasing it from any timer. In this mode, each time the slider moves out from a stroke end (from 0 to an upper value or from 100% to a lower value) the cue list receives a trigger, the fade-in with the next cue begins and the fader level depends on the slider position: practically the fade-out occurs when the slider reaches the other stroke end.

Cue Priority (LTP/HTP)

When two or more cues belonging to two different cue-lists compete for the same channel, the following criterion is followed:

- If the channel is LTP, the priority is assigned to the latest enabled cue (LTP criterion).
- If the channel is HTP, is applied the LTP or HTP criterion (priority assigned to the highest value) as specified in the 'Playback mode' option in the 'General options' window.

Execute a cue-list: Register Playback

Pressing a register key, the first cue of the cue-list linked to the register is played. Pressing it a second time the second cue is played and so on until the first cue starts again. If the cue list is set as 'Sequence' or 'Chase' modes, after the playback of the first cue all the following cues will be played with the pre-set times. If the cue list is set as 'Live' mode, any cue of the cue list can be played pressing the corresponding button in the 'Live' window.

IMPORTANT: the default configuration of the six controllers is 'Playback Master', which means that each slider controls the intensity and the key controls the flash of the respective first six registers, while the remaining six registers have not controllers.

Stop a cue-list: Register Release

To stop or release a register you must press and hold the 'Release' key and, while it is down, press the register key to be stopped, or alternatively press in rapid sequence the 'Release' key and the register key.

IMPORTANT: pressing in rapid sequence two times the 'Release' key will stop all registers currently in playback.

Change the current Register Page

Pressing the 'Page' button the LED correspondent to the current page number gets on. Pressing a Register key while the 'Page' key is down, the current page will change to the correspondent number. Alternatively, the 'Page' key and the register key must be pressed in rapid sequence to recall the correspondent page.

IMPORTANT: pressing in rapid sequence two times the 'Page' key will switch to the next page.

Grand master and group submaster

The Controller Sliders can be configured as 'Grand master' or group submaster, allowing to control manually the intensity of the fixtures in real time. The 'Grand master' and the group submaster influence the HTP channel only, usually the dimmers of the fixture.

If a fixture belongs to two or more groups, the submaster assumes the lower value.

The 'Grand master' controls the dimmer of all the fixtures in the show, reducing further the values already reduced by the group submasters.

IMPORTANT: the keys of the submaster operate as flash while the 'Grand master' key is set as DBO (dead black out).

SETUP

It is possible to enter in the 'Setup' menu pressing the 'Setup' button (always available) from any contextual menu. The 'Setup' menu allows to set various configuration options and tools.

Setup menu:

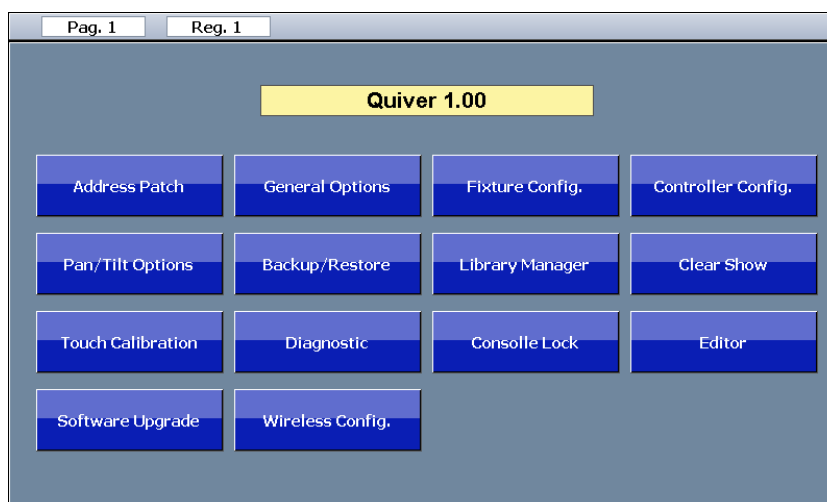

- **Address Patch:** it opens the 'Address patch' window that allows to manage the patch of the show, i.e. to add and/or to remove fixtures from the show setup and to assign to each one the correspondent 'Dmx Start address'.
- **Fixture Config:** window for changing some configuration parameters of the fixtures present in the show. Any configuration changes affect only the fixture in the current show and leave unchanged the fixtures in the library.
- **Controller Config:** configuration and customization of all the controllers.
- **Pan/Tilt Options:** allows to invert and swap the Pan and Tilt function of the show's fixtures.
- **Backup/Restore:** for managing and restoring saved show files, both in SD internal memory and in USB memory.
- **Library Manager:** it manages the fixture library both in the SD internal memory "**SD/lib**" and in the USB memory "**USB/lib**". It allows to copy / move / erase single files and whole folders, both in the SD internal memory and in the USB memory.

- **Clear Show:** it erases all the data of the current show (including the patch configuration and cue programming) and resets the system for a new show. It does not influence the fixture library and previously show backups.
- **Touch Calibration:** this serves for the calibration of the touch screen. The console is delivered with the touch screen calibrated: if, for any reason, a lack of feeling is noted try to re-calibrate the touch screen. To carry out the calibration click to the point specified on the screen with care.
- **Diagnostic:** shows the diagnostic window that allows to verify the correct operations of the hardware interface of the system (excluding USB and DMX output). In case of console malfunctions this option can be useful to exclude hardware problems.
- **Consolle Lock:** restrict the access to all the console's programming and configuring operations, leaving accessible only the playback operations (controllers and register keys). To enable or disable the lock it's required to specify a password. In any case, the console is automatically unlocked simply switching it off and on.
- **Editor:** opens the editor's window.
- **Software Upgrade:** to perform a software update follow the instructions below.
 - 1) Copy the upgrade file (Qdmx.bin) in the root folder of the USB memory, then insert it in the USB port of the console.
 - 2) Press the 'Software Upgrade' button then confirm.
 - 3) The console shuts off and after some seconds the EDIT buttons LED begin to flash: after about one minute the upgrade is completed and the console restarts with the new software version.

NOTE: when the console restarts after a software upgrade, the LCD display flickers for about 30-40 seconds.

IMPORTANT: NEVER switch off the console during the software upgrade.
- **Wireless Config:** configuration of the wireless output (optional).

Address Patch

The first operation that must be done to use the console is the patch of the show, which consists to assign to each fixture a number and the DMX starting address. The number of the occupied DMX channels depends from the fixture type: the assignment is necessary for all the fixtures present in the show to be programmed.

Address Patch window:

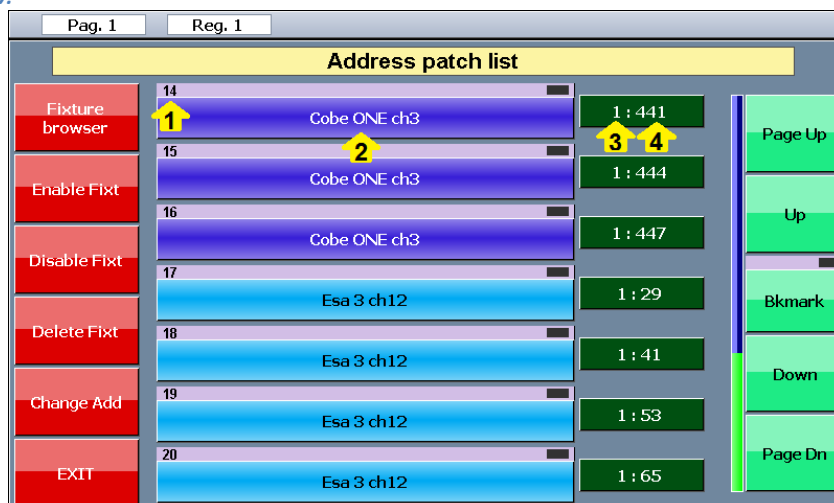

Legend:

- 1) Identifier number of the fixture: the fixtures are ordered by this number.
- 2) Name of the fixture.
- 3) Dmx universe.
- 4) Start address.

Buttons in the ‘Address Patch’ window:

- **Fixture browser:** the fixture browser allows to navigate in the fixture library to choose the fixtures and add them to the show.
- **Enable Fixt:** allows to enable the selected fixture.
- **Disable Fixt:** it allows to disable the selected fixture. All fixtures disabled are not involved during playback and their DMX outputs are not generated.
- **Delete Fixt:** deletes permanently the selected fixtures and their programming in the cue list.
- **Change Address:** allows to change the DMX universe and start address of one or more fixture. If two or more fixtures are selected, their DMX addresses are set in sequence, taking into account the total number of channels occupied by each fixture. If there are not enough DMX channel free, the console disables the fixture in excess to avoid overlapping. In this case the display shows an alert message to highlight the problem.
- **EXIT:** closes the ‘Address patch’ window and returns to the Setup menu.

Fixture browser

Pressing the ‘Fixture browser’ button in the ‘Address patch’ screen you open a window that shows all the folders present in library (typically matching the brand name of the fixture manufacturers). Pressing the corresponding brand button, the list of fixtures of such manufacturer appears:

Fixture Browser window:



Buttons in the ‘Fixture Browser’ window:

- **USB Disk:** allows to explore the library contained in the USB memory.
- **Internal Disk:** allows to explore the library contained in the SD internal memory.
- **Folders:** allows to explore the library backward at the upper folders/brand level.

IMPORTANT

In order to be read by the console, the fixtures saved in the USB memory must be arranged in the following way:

- **The root folder in the USB memory must contain a folder named “LIB”;**
- **The LIB folders must contain the brands’ folders.**
- **Each brand’s folder must contain the library files in .pf or .fxr format.**

For example, a file named ‘Club Spot 150 ch14.pf’ for the Sagitter fixture must be saved in the USB memory with the following path (presuming that the computer sees the USB memory as drive G): **‘G:\LIB\Sagitter\Club Spot 150 ch14.pf’.**

To add a fixture to the patch of the show you must press the correspondent fixture button: the ‘Add fixture’ window will appear to input all other parameters.

Add Fixtures

Pressing a button corresponding to a fixture in the ‘Fixture Browser’ window, the ‘Add Fixture’ appears on the display:

Add Fixture window:

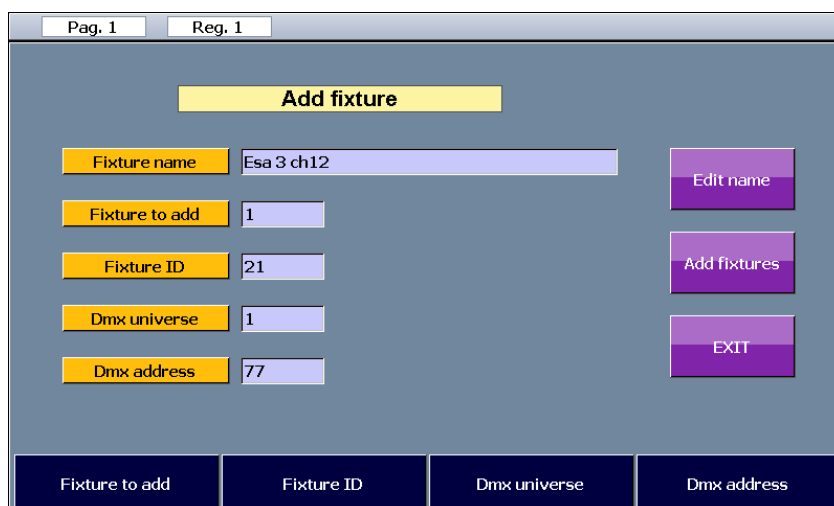

Buttons and Touch Slider in the ‘Add Fixture’ window:

- **Edit name:** allows to change the “Fixture name”, which is copied from the library as default, but may be changed to easily identify the fixtures.
- **Fixture to Add:** allows to change the number of fixtures to add to the patch.
- **Fixture ID:** it’s the identify number of the first fixture to add. If the fixtures to add are two or more they will be enumerated in sequence.
- **Dmx universe:** DMX universe patch of the fixtures. The console manages up to a maximum of 3 DMX universes: the first is managed from the main console and each expansion can manage one more universe.
- **Dmx address:** DMX start address of the first fixture. If two or more fixtures are added, the DMX addresses are assigned in sequence, considering the number of channels occupied by each fixture.
- **Add fixtures:** confirms the fixture setup options and lays them in the patch of the show.
- **EXIT:** leaves the window without patching the fixtures.

To modify the values it’s possible to use the Touch Sliders or to push the buttons on the bottom of the display: this will display a numeric keypad on the screen for the direct input of the values.

General options

The 'General options' window is recalled pressing the button in the Setup menu.

To modify an option you must first select it by pressing on its button and then change its value using the fourth Touch Slider.

General options window:

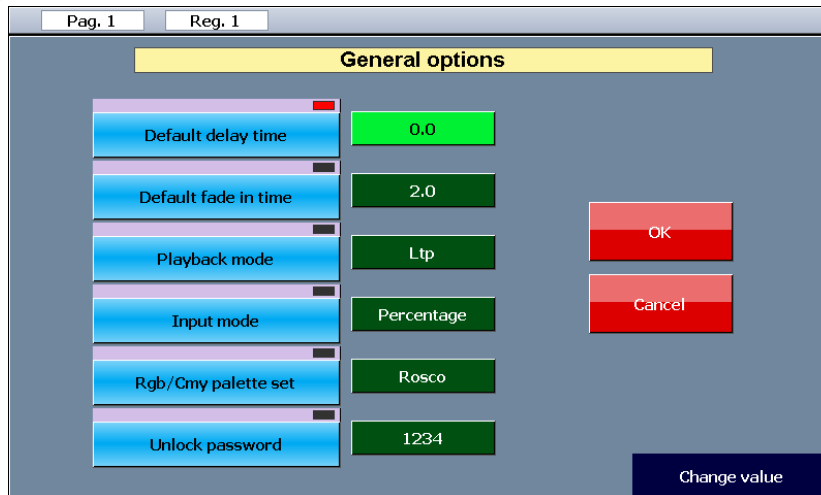

- **Default delay time:** it's the default value of the 'Delay', when a new cue is created its delay time is set at this value.
- **Default fade in time:** it's the default value of the 'Fade-in', when a new cue is created its fade-in time is set at this value.
- **Playback mode:** it can be set as LTP or HTP. This setting affects the criterion for the assignment of the HTP channels (typically the dimmer). When two or more cues belonging to different cue list are challenging the control of the same HTP channel, if it's set as HTP the priority is assigned to the higher value, if it's set as LTP the priority is assigned to the most recent cue activated.
- **Input Mode:** can be set as 'Percentage' or 'Raw'. This option simply changes the display of attributes in the editor. If you choose the 'Percentage' option, the value is displayed in percentage. If you choose the 'Raw' option, the value is displayed as a number between 0 and 255 for 8-bit parameters, while for the 16-bit parameters the values of the most significant part and the least significant part separated by the character '.' are displayed.
- **RGB / Cmy palette sets:** the console includes 4 sets of default palette, *Chris*, *GAM*, *Lee*, and *Rosco*. This option allows you to select the set of palette available in the editor. In general, it is possible to program the cue with a set of palette, change the current set and schedule the remaining cues with the new set.
- **Unlock password:** this is the password that must be entered each time you use the 'Console Lock' and 'Console Unlock' function.

Fixture configuration

This window has been conceived more for verification purposes than for modifying a fixture. We suggest to not use it for modifying the fixture configuration, unless you are an expert user fully acquainted of the effects of the modifications.

This window, recalled pressing its button in the Setup menu, allows to edit some settings of the fixtures used in the current show. All the changes made through this window will affect all the fixtures of the same type (for example: if the show contains 12 fixtures of Scroller type, so the options shown are referred to the 'Scroller' typology, then they are applied to all Scrollers). All changes applied through this function only affect the current show, leaving the fixture library unchanged.

To edit a value, you must select it by pressing the corresponding button and use the fourth Touch Slider to set the new value.

Fixture configuration window:

Pag. 1		Reg. 1				
Esa 3 ch12	Type	Htp/Ltp	Path	Stand by	Hilite	Locate
Pan	Pan Tilt	Ltp	Linear	-	-	128.0
Tilt	Pan Tilt	Ltp	Linear	-	-	128.0
PT-Speed	Pan Tilt	Ltp	Linear	-	-	0
Shutter	Intensity	Ltp	Linear	-	-	255
Dimmer	Intensity	Htp	Linear	0	255	255
Rotation lens	Prism	Ltp	Linear	-	-	0

Buttons: Prev Fixt, Next Fixt, Pg Up, Pg Dn, OK, Cancel, Edit

Buttons and Touch Slider in the 'Fixture configuration' window:

- **Prev Fixt, Next Fixt:** buttons to select the various fixture types that are included in the show.
- **Page up, Page Dn:** buttons to scroll the window, useful when the fixture has more than 6 parameters.
- **OK:** stores the changes and goes back to the Setup menu.
- **Cancel:** goes back to the Setup menu without storing the changes.
- **Edit:** label to inform the user that the fourth Touch Slider is assigned to modify the value.

Adjustable Options:

- **Type:** can get the values *Intensity, Pan Tilt, Color, Gobo, Prism or Blade*.
- **Htp/Ltp:** affects the priority criterion of the parameters.
- **Path:** type of fade applied to the parameter. The linear parameters (ex. dimmer, pan, tilt, zoom) have typically a *Linear* fade, while the slot wheels have typically a *Snap start* fade.
- **Stand by:** usually a LTP parameter type is set at the stand-by value when no cue controls it. If the stand-by value is not defined the parameter stays stable at the latest value set by a cue or by the editor. For HTP parameters this option must have 0 value.
- **Hilite:** this value is assigned to the parameter when the 'Hilite' status is activated.
- **Locate:** this value is assigned to the parameter when the 'Locate' button is pressed.

Controller configuration

This window, recalled by pressing the button in the Setup menu, allows to customize the 6 slider and the correspondent buttons of the console.

The Controller Sliders can be configured as 'Grand master', 'Group submaster' or as 'Playback master'. In the latter case it can be configured for each cue list in four modes: Master Intensity, Master Speed, Master Size or Cross-Fade (see Qlist paragraph).

Obviously it's possible to set only one slider as Grand master.

Controller configuration window:

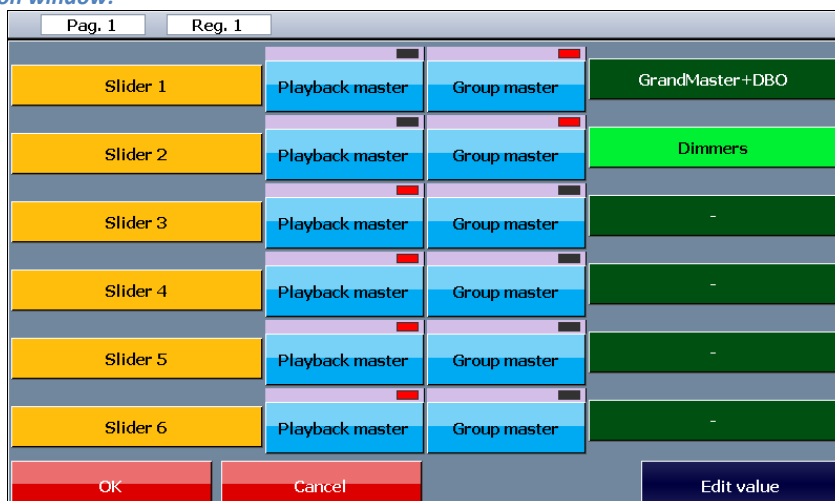

Buttons and Touch Slider in the 'Controller configuration' window:

As default the sliders are set as playback master. To configure them as group master press the Group master button and using the fourth Touch Slider select the group to be controlled.

Pan Tilt options

For every fixture of the show it's possible to set the inversion of pan and/or tilt and their possible exchange. The window shows only the fixtures equipped with the pan and tilt parameters. To open this window, press the 'Pan/Tilt options' button from the Setup menu.

Pan/Tilt Options window:



Buttons in the 'Pan Tilt options' window:

Press the button of the fixture you require to modify: for example, for symmetrical light effects between right/left or top/bottom fixtures. Save the setting using the Save and Exit button.

Backup/Restore

The Backup/Restore window allows to access a number of functions for saving and restoring a show.

The console has a working area called current show. The current show contains: a copy of the fixture libraries used in the show, fixture patching information, various setting and the cue and palette programs. In this way the current show is an independent entity that defines completely the programming of a show and any future modification to the library will not affect an existing show, because each show uses a copy of the library created in the time of the patch.

The backup saves all the information of the current show in the SD internal memory or in the USB memory.

The restore loads a show previously saved in the SD or USB memory into the current show and therefore all data already present in the working area are overwritten.

IMPORTANT: the backups saved in the external USB memory are stored as subfolders of the BACKUP folder (located in the root folder). It is not allowed to operate directly with files and folders by means of a personal computer. Use exclusively the Backup/Restore command of the console.

Backup/Restore window:

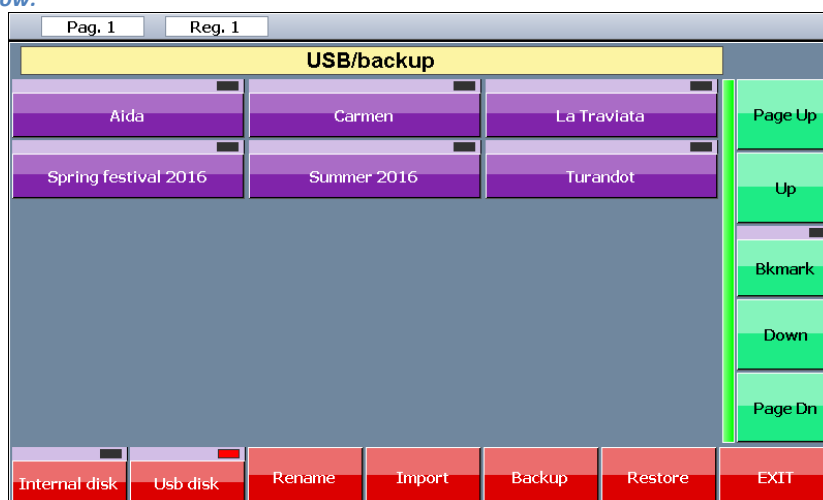

Buttons in the 'Backup/Restore' window:

- **Internal disk:** shows the contents of the SD internal memory.
- **USB disk:** shows the contents of the USB memory.
- **Rename:** changes the name of a backup.
- **Export:** copies a backup from SD internal memory to USB memory.
- **Import:** copies a backup from USB memory to SD internal memory.
- **Backup:** stores a new backup of the current show.
- **Restore:** restores in the working area (as current show) the selected backup.

Backup/Restore contextual menu

Pressing the 'Menu' key recalls the contextual menu with the following options:

Backup/Restore contextual menu:

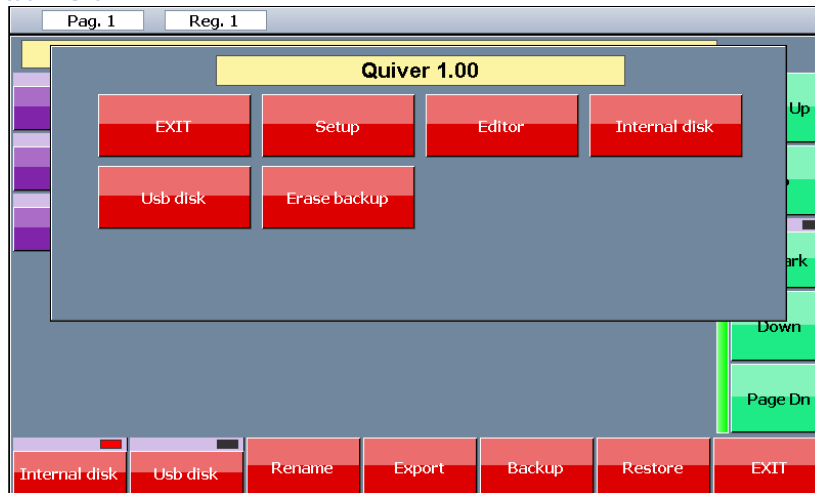

- **Exit:** closes the contextual menu.
- **Setup:** closes the Backup/restore window and goes back to the Setup menu.
- **Editor:** closes the Backup/restore window and opens the editor window.
- **Internal disk:** selects the SD internal memory.
- **USB disk:** selects the USB memory.
- **Erase backup:** deletes permanently the selected backup.

Library manager

This option, recalled pressing the button in the Setup menu, allows to manage the fixture library (duplicate, copy and rename files or folders). To show the contents of a folder (each folder correspond to a brand of fixture) press the correspondent folder button.

IMPORTANT

In order to be read by the console, the fixtures saved in the USB memory must be arranged in the following way:

- **The root folder in the USB memory must contain a folder named "LIB";**
- **The LIB folders must contain the brands' folders.**
- **Each brand's folder must contain the library files in .pf or .fxr format.**

For example, a file named 'Club Spot 150 ch14.pf' for the Sagitter fixture must be saved in the USB memory with the following path (presuming that the computer sees the USB memory as drive G):
'G:\LIB\Sagitter\Club Spot 150 ch14.pf'.

Library Manager window:



Buttons in the 'Library Manager' window:

- **Folders:** allows to explore the library at the upper folders/brand level.
- **Export folder:** copies the current folder from the SD internal memory to the USB memory.
- **Export file:** duplicates the selected file in the same folder of the USB memory. If the folder does not exist it will be created.
- **Import folder:** copies the current folder from the external USB memory to the SD internal memory.
- **Import file:** copies the selected file in the same folder of the SD internal memory. If the folder does not exist it will be created.
- **Rename folder:** allows to modify the name of the current folder.
- **Rename file:** allows to modify the name of the selected file.
- **Copy file:** this button is used, together with the 'Paste file' button, to perform "Copy and Paste" operations. It stores the current file in the internal memory and makes it available for Paste operations. The LED indicator on the Paste button becomes green to show that the Paste buffer now contains a file. Practically it allows to duplicate files on defined user folders to create custom libraries.
- **Paste file:** this button is used, together with the Copy file buttons, to perform "Copy and Paste" operations. If the LED indicator is turned off, the Paste buffer is empty and therefore it cannot be used. "Copy and Paste" operations are primarily used to copy a file from one folder to another or from one disk to another.

'Library manager' contextual menu:

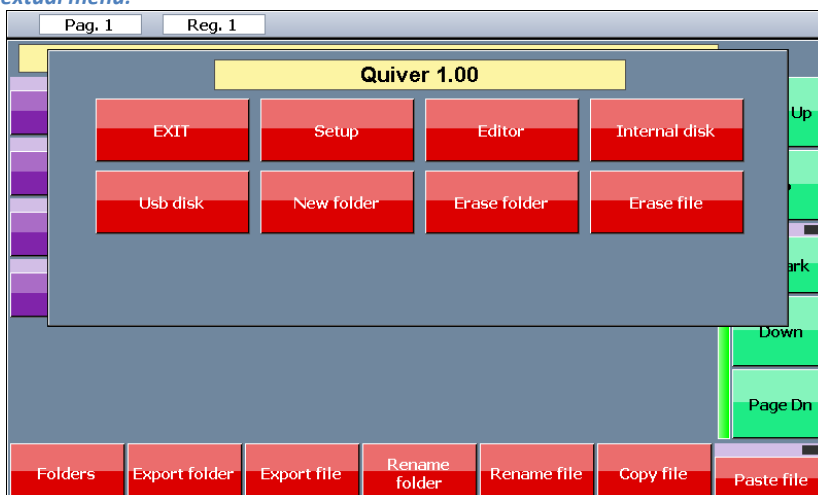

Buttons of the 'Library Manager' contextual menu:

- **EXIT:** closes the contextual menu.
- **Setup:** closes the Library manager window and goes back to the Setup menu.
- **Editor:** closes the Library manager window and opens the editor window.
- **Internal disk:** selects the SD internal memory.
- **USB disk:** selects the USB memory.
- **New folder:** creates a new folder or brand.
- **Erase folder:** deletes permanently the current folder and all files contained.
- **Erase file:** deletes permanently the selected file.

Diagnostic

This window, recalled pressing the button in the Setup menu, allows to verify the correct functioning of all the console's hardware and expansions, with the exceptions of Dmx outputs and USB port.

'Diagnostic' window:

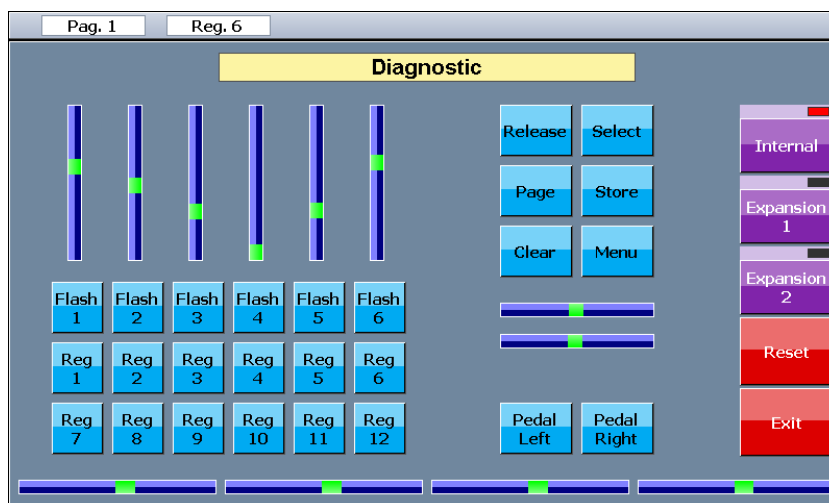

When any console's command is activated (keys, slider potentiometers, Touch Slider, joystick), the action is shown on the screen, allowing to check whether the command is working properly.

Buttons in the 'Diagnostic' window:

- **Internal, Expansion 1, Expansion 2:** for testing the sliders and keys included in the console or in the expansions 1 or 2.
- **Reset:** takes back at the initial state all graphical elements on the screen.
- **Exit:** closes the Diagnostic window and goes back to the Setup menu.

Wireless configuration

This window, recalled pressing the button in the Setup menu, allows to set up the wireless module (optional).

'Wireless configuration' window:

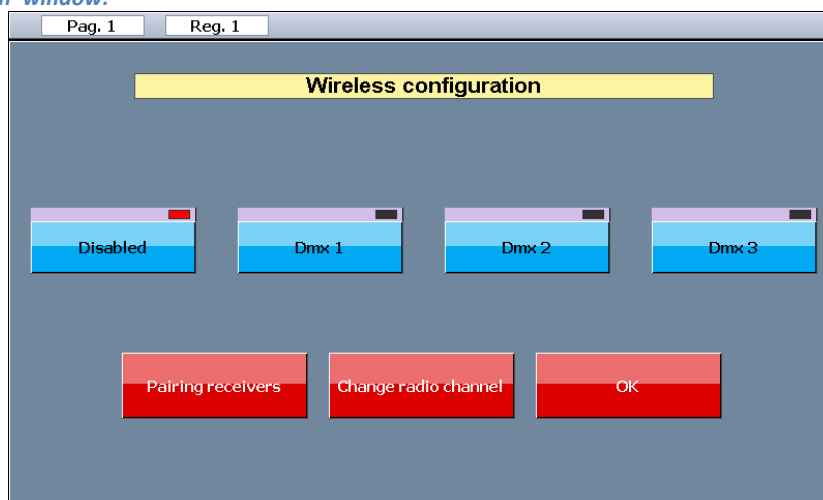

Buttons in the 'Wireless configuration' window:

- **Disabled:** the wireless output is off.
- **Dmx1, Dmx2, Dmx3:** it allows to choose which DMX universe is transmitted through the wireless among Dmx1, Dmx2 or Dmx3. Note that it's possible to select Dmx2 or Dmx3 also without any expansion installed.
- **Pairing receivers:** it's used to pair the receivers to the console. The receivers must not be associated to any other transmitter (see also the manual of the receiver).
- **Change radio channel:** changes the communication radio channel (radio frequency) between the console and the receivers. It could happen that other radio devices are working in the same frequency of the console wireless module, making difficult the communication: in this case changing the communication channel could fix the problem.

QUIVERX EXPANSION

The QUIVER console allows to link one or two units of QUIVERX expansion. Each connected unit makes available 12 extra registers and adds 12 playable cue-list and 1 DMX universe. The connection between the console and the expansions must be done through a single CAT5 UTP (1mt) cable that is supplied with the equipment. The connection can be done with the console switched on or off: if the console is on, it recognizes the expansion automatically at the moment of linking, making it available immediately.

IMPORTANT: if using only one expansion, you must connect it to the console's EXP 1 port.

When the two expansion are connected, the console is capable to execute 3 pages of cue-list simultaneously (for a total amount of 36 cue-list): 12 cue-list of the first page (current page) with the registers of the console, 12 cue-list of the second page with the expansion 1 and 12 cue-list of the third page with the expansion 2.

Front Panel

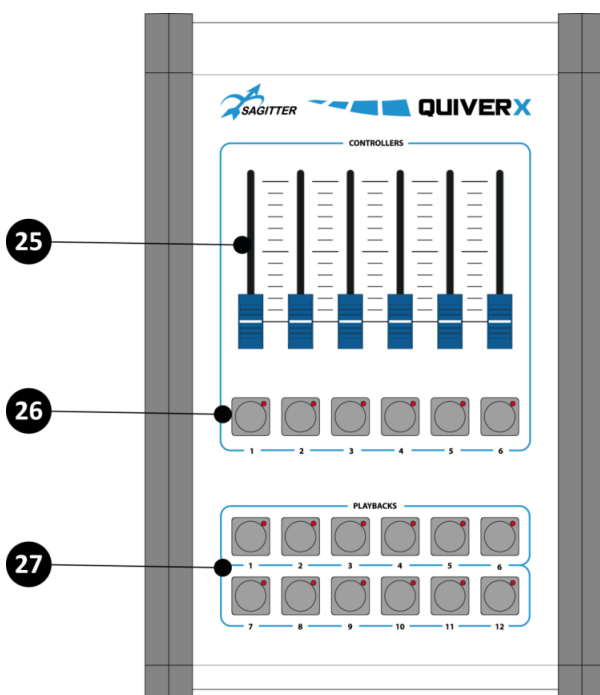

Rear Panel

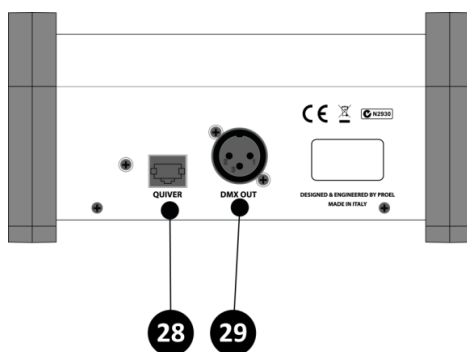

Description

- 25. Programmable Controller Sliders, usually set for registers 13 to 18 or 25 to 30.
- 26. Programmable Controller Switches, usually set for registers 13 to 18 or 25 to 30.
- 27. Register Switches.
- 28. RJ45 socket for console connection.
- 29. DMX output connector (universe 2 for expansion 1, universe 3 for expansion 2).

Dimensions

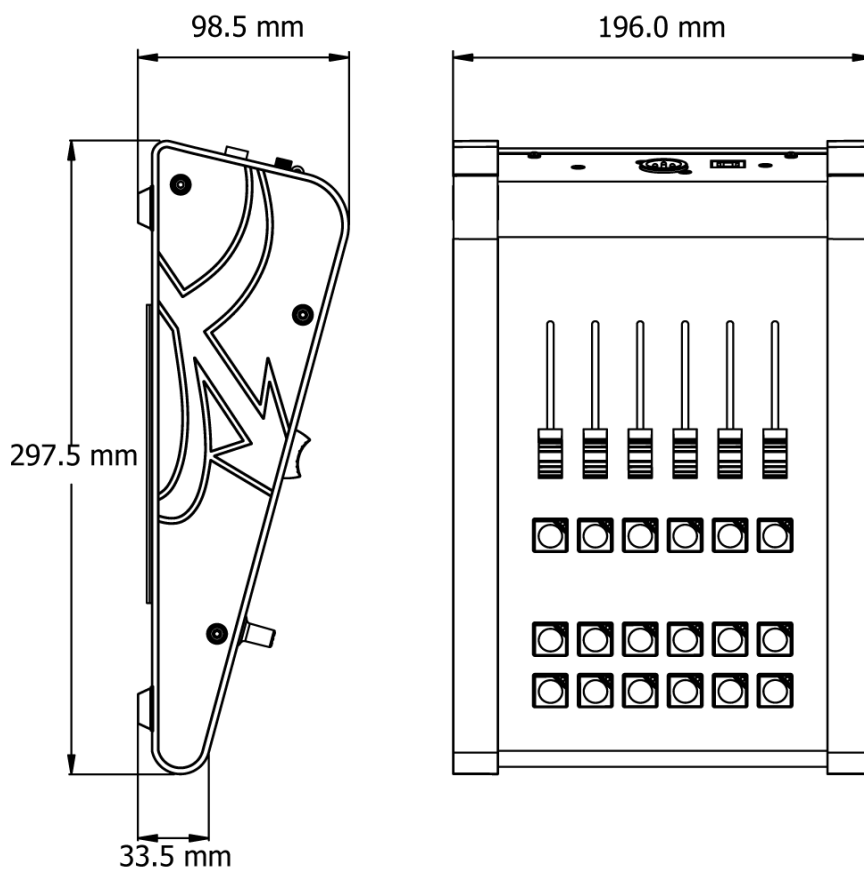

Fixture Editor for Windows

The FixturEditor.exe program is included in the USB pen drive supplied with the console and can be also downloaded from the www.sagitter.com web site. This software can run in any computer with Windows operating system: with a double click on the .exe file you can run it also directly from the USB pen drive or you can copy it to any folder on your PC's hard disk.

The program allows to create custom fixtures starting from the data written on the user manual of the fixture, save them on the USB pen drive and copy them on the console by means of the Library Manager.

Even if the program is very easy to use, the creation of the fixture is recommended only for expert users.

After launching the program, the following screen appears.

Fixture Editor:

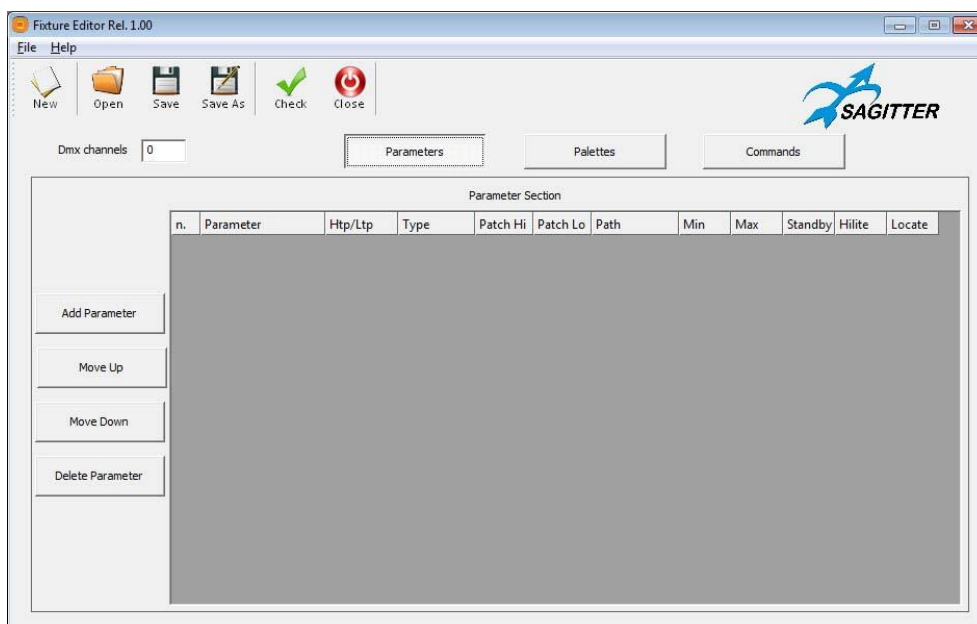

Using the commands 'Add Parameter', 'Move Up', 'Move Down', 'Delete Parameter' you can edit the parameters, taking them from the user manual of the fixture to be created.

In the following two figures you can see the editing of some parameters for the Sagitter fixture 'Club Spot 150 ch14.pf': in this specific case the control has been implemented through 14 DMX channels, which allows a superior resolution for Pan and Tilt.

Fixture Editor 'Parameters':

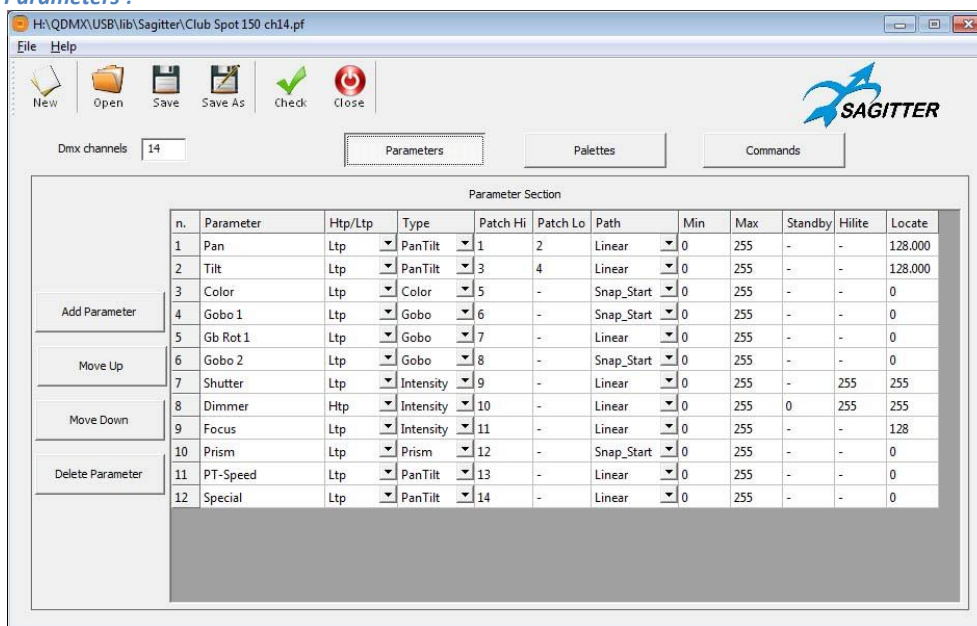

From user manual of the fixture, choose the 14 DMX channel mode indicate by the arrow:



Channel mode			Function	Value	Description
12	14	16			
1	1	1	PAN	000 – 255	Pan movement
	2	2	PAN fine	000 – 255	Pan fine movement
2	3	3	TILT	000 – 255	Tilt movement
	4	4	TILT fine	000 – 255	Tilt fine movement
3	5	5	Color wheel	000 – 015	Open
				016 – 031	Red
				032 – 047	Cyan
				048 – 063	Green
				064 – 079	Yellow
				080 – 095	Magenta
				096 – 111	Blue
				112 – 127	Orange
				128 – 189	Forward rotation from fast to slow
				190 – 193	Stop rotation
				194 – 255	Backwards rotation from slow to fast
4	6	6	Gobo 1 wheel	000 – 009	Open
				010 – 019	Gobo 1
				020 – 029	Gobo2
				030 – 039	Gobo3
				040 – 049	Gobo4

Once all DMX channels have been set, it's also possible to edit some palette (usually for the classic color and most used Gobo) and some special command (usually the global Reset).

Fixture Editor 'Palettes':

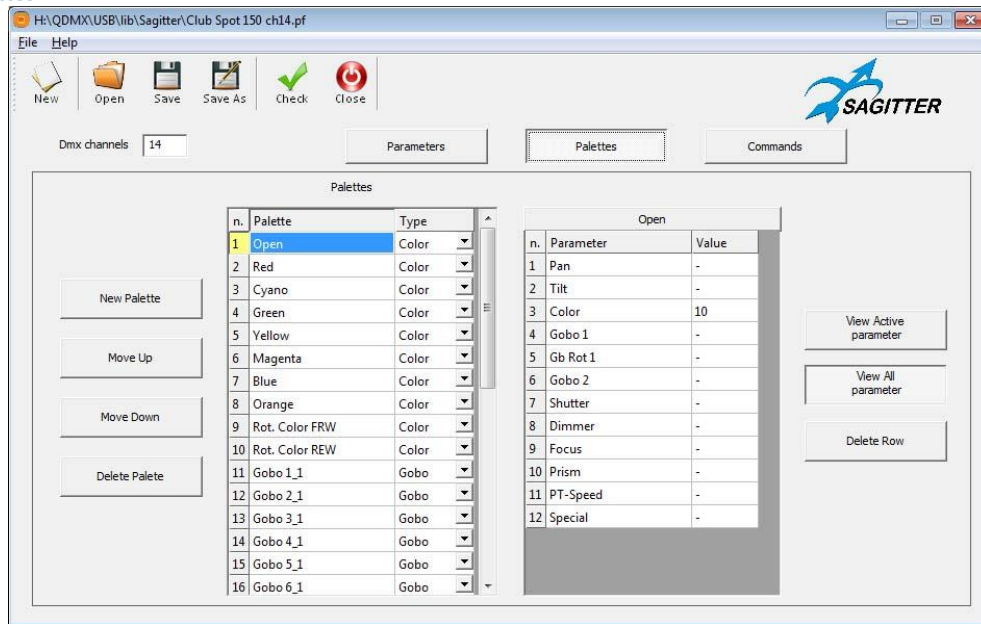

Fixture Editor 'Commands':

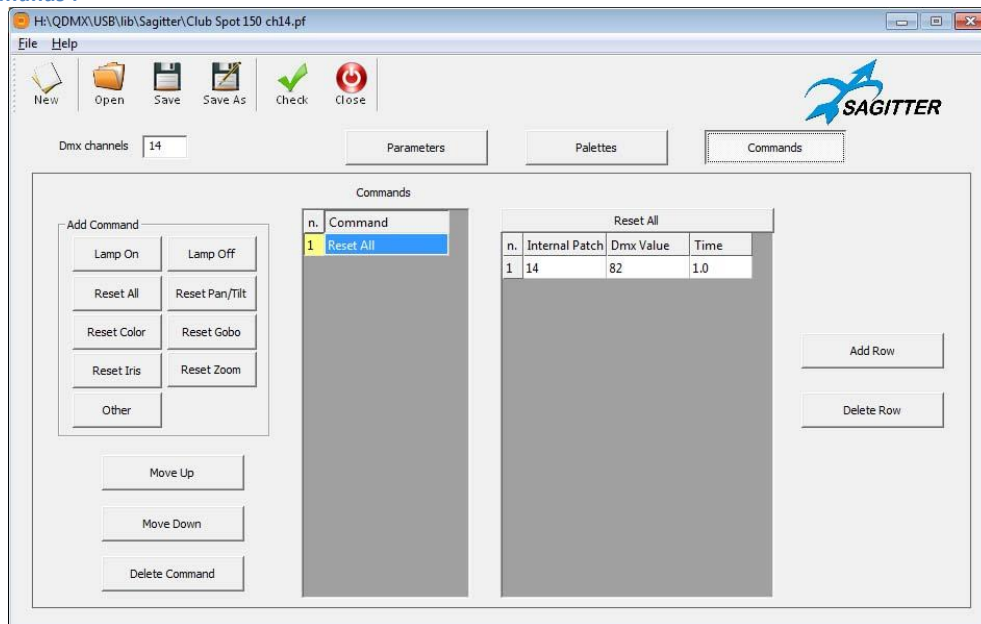

After the data editing has been completed, it's possible to make a quick check using the 'Check' button, in order to spot any big error in the DMX channel. If the 'Check' result is positive, you can proceed to save the fixture in the proprietary format of the QUIVER console, which is a file type '**.pf**'. At this point, we recommend to test the new fixture file the with some cue from the console, before using it in a show.



PROEL S.p.A.

(World Headquarters - Factory)

Via alla Ruenia 37/43

64027 Sant'Omero (Te) – Italy

Tel: +39 0861 81241

Fax: +39 0861 887862

www.proel.com