

Data sheet
AS-10 / ASP-10



Arc-Series

Architectural Sound Design.



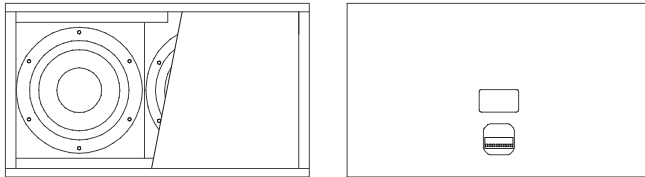

Fohhn® AS-10 / ASP-10
Ultra compact bass system, 300 W, 2x6", vented design.

Description

The Fohhn® AS-10 is a ultra compact bass system, 300 W, 2x 6", vented design, 9 kg, without crossover for 2-channel active operation.

Fohhn® bass systems are characterised by their clear, powerful reproduction of bass frequencies. All models are fitted with top-quality speakers. The compact housings are made from high-quality multiplex and available in all RAL colours.

Option: ASP-10 with integral stereo coss over

ntegral stereo crossover for separating bass and mid-high frequency. (Low pass 130Hz / 12dB / oct.; high pass 130Hz / 6dB / oct.). Impedance of 2x 8 ohms. Mid-high speakers can be connected via the output.

Optional versions

Optional special weatherproof plastic coating.
 Optional 100 volts version. All RAL colours

Connections

8-pole Phoenix connector.

Mounting brackets

VAS-14 Set - Set of 4x L-brackets for simply and flexible ceiling and wall mounting of the subwoofer.

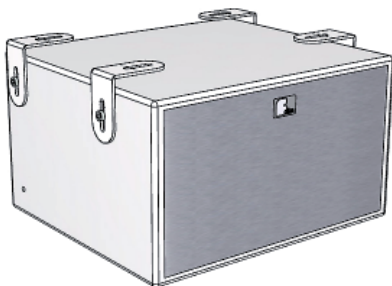

Technical specifications

AS-10

electro-acoustical features

acoustic design	vented design
components	2x 6" long excursion, neodymium
power rating	300 W
SPL max.	120 dB
frequency range	40 Hz – 500 Hz
Impedance	4 ohms

ASP-10

with integral passive stereo X-over (FX)

lo-pass-filter	130Hz / 12dB / Oct.
hi-pass-filter	130Hz / 6dB / Oct.
nominal impedance	2x 8 ohms

features

enclosure	multiply birch wood
protection grille	metal, powder coating
rigging points	6x M8 thread
connections	8-pole Phoenix connector
standard colour	black, textured paint
front design	acoustic foam
dimensions (W x H x D)	38 x 25 x 44 cm
weight	9 kg

optional features

optional colours	all RAL-colours
weather resistance	scratch-proof plastic coating

The manufacturer reserves the right to make technical modifications according to legal regulations stipulating the continual improvement of product features.

Controlling Arc-Series speakers

1. Fohhn system DSP amplifiers

Fohhn offers a range of specially adapted system DSP amplifiers for controlling Arc speaker systems, which guarantee maximum sound performance and operational reliability for your Fohhn products. As manufacturers of speaker, amplifier and DSP technology, we know our systems inside and out right down to the smallest detail and are therefore in a perfect position to provide our users with the best overall system.

Fohhn System DSP amplifier are offering following advantages:

Integrated high-performance DSP technology:

- quick set-up,
- minimal space requirements in electronics cabinet,
- minimal cable requirements,
- fewer cable faults,
- controller and amplifier can be controlled and monitored using the same software.

Dual DSP technology

The DSP amplifiers contain 2 separate DSP engines with enormous capacity and processing power for 5 digital audio devices (DSP-1) and Fohhn specific speaker databases (DSP-2).

Remote monitoring and control

Integrated temperature and operating time monitor, status indicator / protection, remote control capability / network compatibility using a laptop, wall installation modules or media control systems.

Fohhn® dual DSP technology

DSP-1: Integrated digital audio devices

Each amplifier channel has a:

- programmable 10 band parametric EQ,
- compressor/limiter/noise gate,
- delay,
- X-over function,
- top-quality pink noise and sweeptone generator

DSP-2: Speaker management

An integrated speaker database guarantees excellent sound quality and protection for all Fohhn speaker types. A sophisticated algorithm developed by Fohhn engineers and adapted to each speaker allows the individual monitoring and adjustment of bass, mid and high ranges.

1.1 Amplifier recommendations for the Arc-Series



D-2.750

2 channel operation, 2x 750 W / 4 ohms,
2x 390 W / 8 ohms

Fohhn Audio DSP, display, remote control

D-4.750

4+2 channel operation, 4x 750 W / 4 ohms,
4x 390 W / 8 ohms

2x DSP line out channels for controlling a conventional amplifier

Fohhn Audio DSP, display, remote control

	Arc-Tops										Linea	Arc-Subs										
	AT-05	AT-06	AT-07	AT-08	AT-09	AT-10	AT-20	AT-21w	AT-30	AT-35	AT-40	AT-50	AT-66	AL-10-150	AS-10	ASP-10	AS-20	ASP-20	AS-30	ASP-30	AS-40	ASP-40
D-2.750	x	x	x	x	x	x	x	x	x					x	x	x	x					
D-4.750	x	x	x	x	x	x	x	x	x					x	x	x	x					
D-2.1500									x	x	x	x	x						x	x	x	x
A-2.2100										x	x	x	x						x	x	x	x

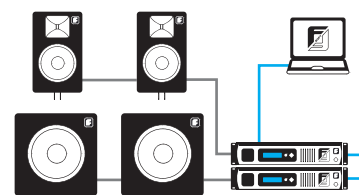

2x Sub passive / 2x Top passive
2x DSP amplifier (D-Series or A-Series)

Controlling Arc-Series speakers

2. Standard amplifiers combined with Fohhn controllers

Standard amplifiers / 100V amplifiers / multichannel amplifiers combined with Fohhn FC-9 DSP system controllers

All of the speaker systems in the Fohhn Arc-Series can be operated in combination with standard amplifiers (e.g. Bittner amplifiers). Each Fohhn speaker model has a linear design, neutral sound adaptation function and is fitted with an integrated crossover with electronic tweeter protection.

We recommend integrating the FC-9 Fohhn DSP system controller for applications involving standard multichannel amplifiers, 100V amplifiers or monitored amplifiers according to EN 60849.

The FC-9 guarantees maximum sound quality, operational reliability and performance features that no other standard controller can offer in combination with our Fohhn speakers.

Sound quality. Reliability. Intelligent control.

- * Fohhn DSPs guarantee maximum sound performance
- * 5 premium audio tools such as Parametric EQ are integrated
- * Integral speaker and amplifier database for maximum operating reliability
- * Remote monitoring/operation, network-compatible
- * Automatic amplifier calibration function CAS
- * 8 input switching contacts for easy system integration
- * Perfect adaptation to all standard amplifiers

FC-9 DSP system controller



DIN EN 60849 (VDE 0828)

Bittner amplifiers



BITTNER
AUDIO

In addition to our special Fohhn® DSP amplifiers, we also offer the complete range of amplifiers manufactured by Bittner Audio for low-ohm or 100 volt applications. Bittner Audio offers solutions such as multichannel amplifiers with eight standard channels and important features for integration in electroacoustic emergency warning systems according to DIN EN 60849 (VDE 0828). Contact us for more information!

Advantages of the FC-9 controller:

Perfect adaptation to all standard amplifiers

Automatic amplifier calibration function and integrated amplifier database for perfect adaptation.

Dual DSP technology

The FC-9 contains 2 separate DSP engines with enormous capacity and processing power for Fohhn specific speaker databases and 5 digital audio devices.

Integrated speaker database

Guarantees excellent sound quality and protection for all Fohhn speaker types.

A sophisticated algorithm developed by Fohhn engineers and adapted to each speaker allows the individual monitoring and adjustment of bass, mid and high ranges.

Remote monitoring and control

Remote control capability / network compatibility using a laptop, wall installation modules or media control systems.

8 input switching contacts

The FC-9 has 8 input contacts. The inputs can be utilized to switch between the different presets of the FC-9, as well as other Fohhn-Net devices. With two inputs and two pushbuttons (shutters) connected to them, a volume control can be realized as well.

4 inputs / 6 outputs (24 nodes)

A programmable 10-band parametric EQ, compressor/ limiter/noise gate, delay, X-over function, top-quality pink noise and sweptone generator are available at each output, allowing you to conveniently adapt the Fohhn system to the room acoustics or your own personal requirements.

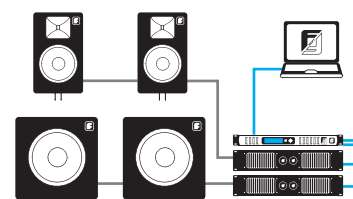

2x Sub passive / 2x Top passive
2x standard amplifiers
1x DSP system controller FC-8

Remote control and network ability of Fohhn devices with integrated DSP

FR-10

remote control wall panel designed for the remote operation of Fohhn devices with integrated DSP.



Description

The FR-10 is a wall mount remote control module designed for the remote operation of Fohhn DSP amplifiers, DSP controllers and active Fohhn speakers systems. The FR-10 is extremely easy to operate because the controls are so well arranged. It is virtually impossible for the end customer to make operating errors because the only operating elements are the 8 labelled buttons.

Easy handling

Control up to 32 Fohhn devices individually with this stylish FR-10 wall panel. 8 programmable buttons can be configured to control the overall volume of a system, the volume in different zones or presets for different room effects, for example. The system also has a special function that confirms whether all commands have been executed successfully. The buttons indicate this by changing red or green shortly after they are pressed. For example, if a device is not switched on, the button changes red to indicate that a command could not be executed. This additional monitoring function ultimately contributes to the overall operating reliability of your system. The wall panel is easy to configure using a standard computer with intuitive Fohhn-Net Remote software installed.

Connections

Two terminal strips (paralleled). Alternative connection via standard 4-wire telephone cable.

Applications

The FR-10 is ideal for training rooms, hotels, churches, halls, restaurants or any venue where a simple, efficient system is required to control your audio equipment from a central location.

The FR-10 is also ideal for projects where complex media control systems are not viable or inappropriate, but the user wishes to control the speaker system centrally.

FR-20

19" remote control unit can be controlled via conventional external buttons or switches.



Description

The FR-20 can be controlled via conventional external buttons or switches (e.g. Jung, Vitra, etc.) or switching contacts (e.g. media control system). Buttons and switches may come in the form of a wall installation module or an individually manufactured control panel, for example.

Presets stored in the connected Fohhn DSP devices are activated simultaneously and settings for different scenarios such as speech, music, empty room, full room, etc are loaded when the buttons/switches are pressed. You can also adjust the volume quickly and easily in 1 dB increments using the FR-20. A maximum of 31 Fohhn devices connected to the network can be activated simultaneously at the press of a single button.

Integration in a media control system

The FR-20 allows the convenient integration of all DSP-controlled Fohhn devices into media control systems (e.g. AMX, Crestron) by means of 8 switching contacts or RS-485 interface.

Integration in a EIB bus technology

One building, one concept, one system.

Fohhn systems equipped with a FR-20 distribution switch comply with the „European installation bus technology“ standard, including all operating comforts.

Applications

The FR-20 is ideal for training rooms, hotels, churches, halls, restaurants, clubs, bars and many other venues.

For simple, reliable remote operation of your audio system without having to install complex, expensive media control systems.



VAS-14

VAS-14 Set - Set of 4x L-brackets for simply and flexible ceiling and wall mounting of the subwoofer.

Variation 1



Variation 2



Variation 3



Variation 4



Views of AS-10 / ASP-10

Front view

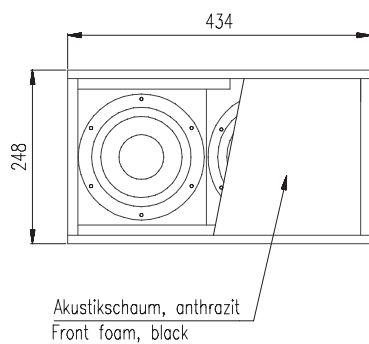

Side view

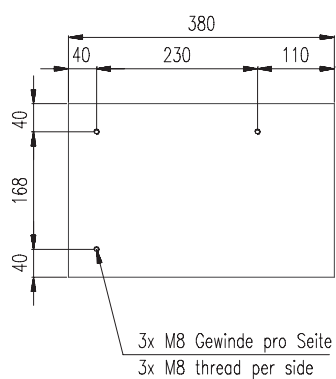

Top View

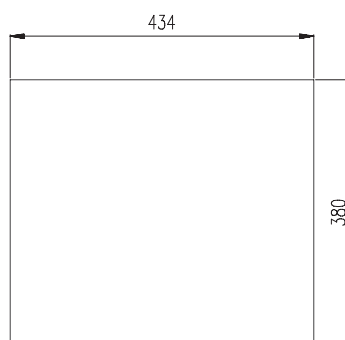

Rear view

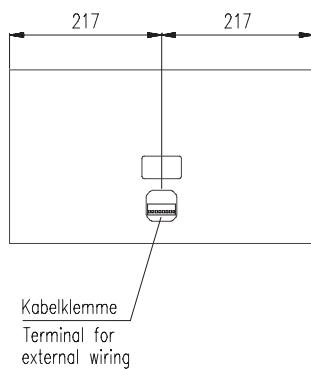

Bottom view

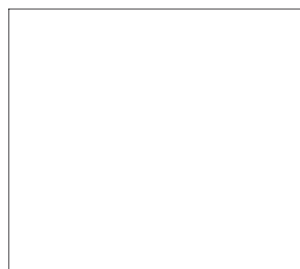

Mounting brackets VAS-14 for AS-10 / ASP-10

Front view variation 1

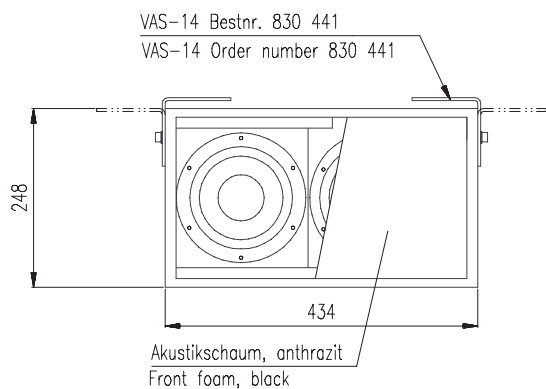

Rear view variation 1

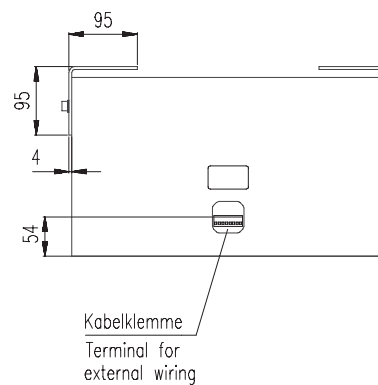

Top view variation 1

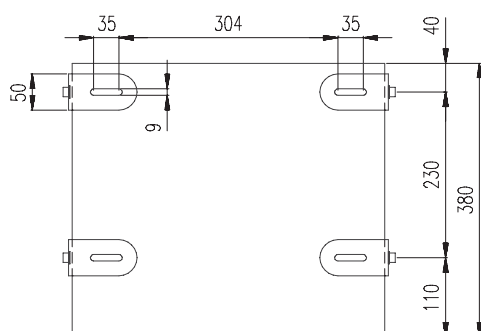

Side view variation 1

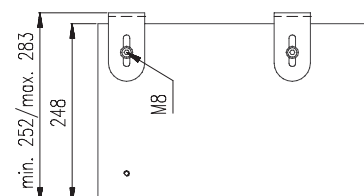

Top view variation 2

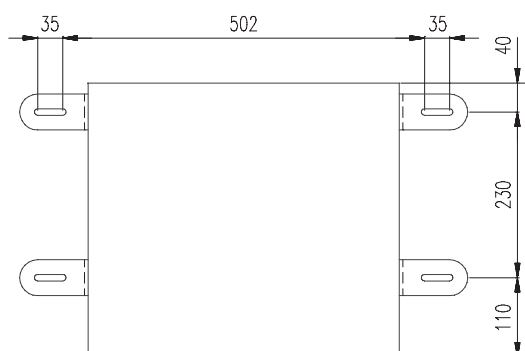

Side view variation 2

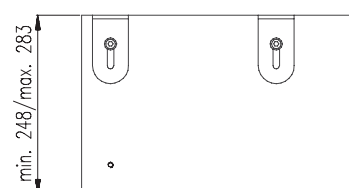

Mounting brackets VAS-14 for AS-10 / ASP-10

Front view variation 3

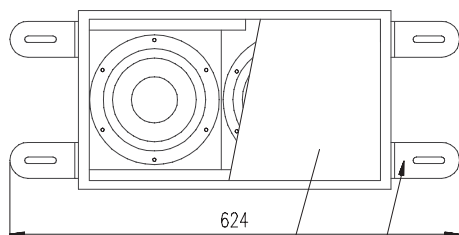

Akustikschaum, anthrazit
Front foam, black

VAS-14 Bestellnr. 830 441
VAS-14 Order number 830 441

Rear view variation 3

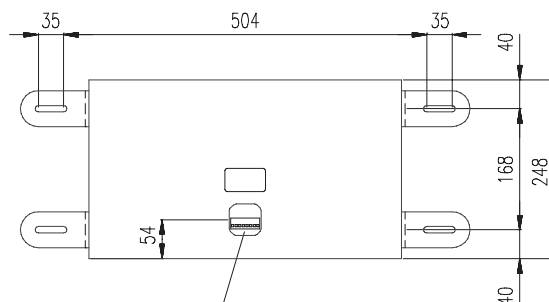

Kabelklemme
Terminal for
external wiring

Side view variation 3

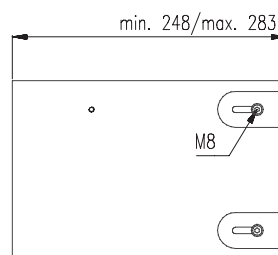

Rear view variation 4

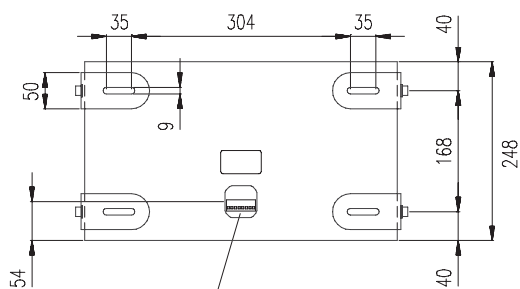

Kabelklemme
Terminal for

Side view variation 4

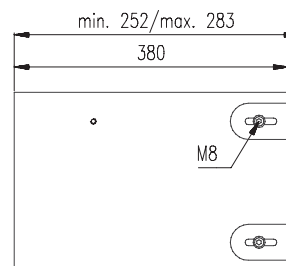

SOUNDS PERFECT. IS PERFECT.

Fohhn audio systems. The ultimate all-round audio experience.

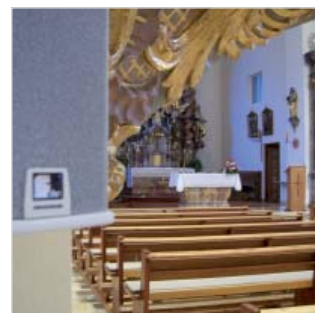
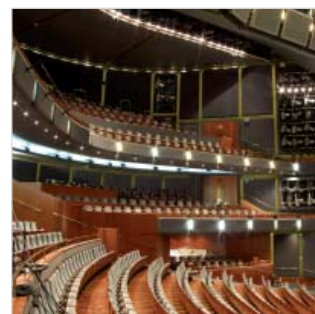
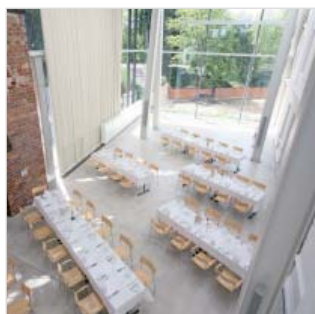
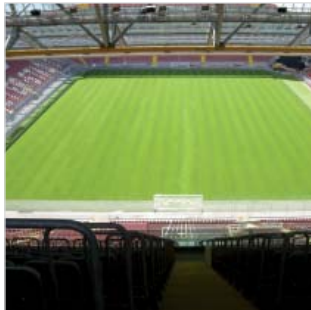

■ German quality
■ engineered and made
■ by Fohhn®

Fohhn Audio AG

Hohes Gestade 3-7

72622 Nürtingen

Germany

Tel. +49 7022 93323-0

Fax +49 7022 93324-0

www.fohnn.com

info@fohnn.com