

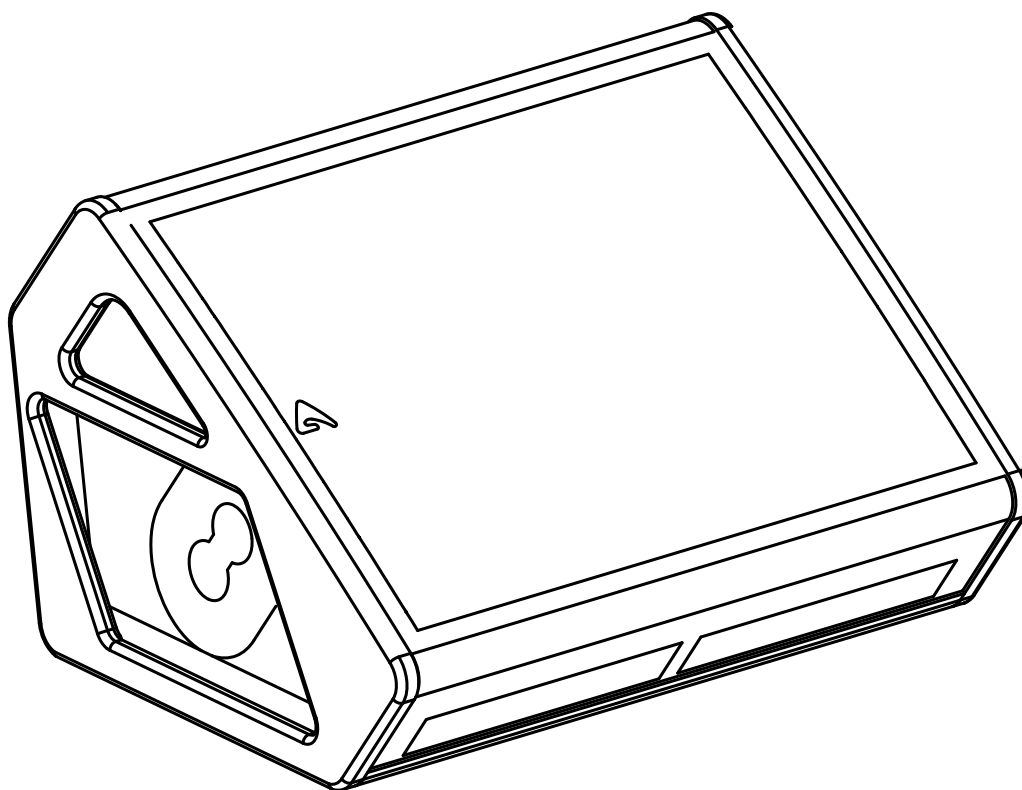

# CX15AV2

Powered Processed Stage Monitor



## USER MANUAL

revision 2023-09-05





# IMPORTANT SAFETY INSTRUCTIONS

## Watch for these symbols:



The lightning flash with arrowhead symbol within an equilateral triangle is intended to alert the user to the presence of uninsulated “dangerous voltage” within the product’s enclosure, that may be of sufficient magnitude to constitute a risk of electric shock to persons.



The exclamation point within an equilateral triangle is intended to alert the user to the presence of important operating and maintenance (servicing) instructions in the literature accompanying the appliance.

1. Read these instructions.
2. Keep these instructions.
3. Heed all warnings.
4. Follow all instructions.
5. Do not use this apparatus near water.
6. Clean only with dry cloth.
7. Do not block any ventilation openings. Install in accordance with the manufacturer’s instructions.
8. Do not install near any heat sources such as radiators, heat registers, stoves, or other apparatus (including amplifiers) that produce heat.
9. Do not defeat the safety purpose of the polarized or grounding-type plug. A polarized plug has two blades with one wider than the other. A grounding-type plug has two blades and a third grounding prong. The wide blade or the third prong are provided for your safety. If the provided plug does not fit into your outlet, consult an electrician for replacement of the obsolete outlet.
10. Protect the power cord from being walked on or pinched, particularly at plugs, convenience receptacles, and the point where they exit from the apparatus.
11. Only use attachments/accessories specified by the manufacturer.
12. Use only with the cart, stand, tripod, bracket, or table specified by the manufacturer, or sold with the apparatus. When a cart is used, use caution when moving the cart/apparatus combination to avoid injury from tip-over.
13. Unplug this apparatus during lightning storms or when unused for long periods of time.
14. Refer all servicing to qualified service personnel. Servicing is required when the apparatus has been damaged in any way, such as power supply cord or plug is damaged, liquid has been spilled or objects have fallen into the apparatus, the apparatus has been exposed to rain or moisture, does not operate normally, or has been dropped.
15. Warning: to reduce the risk of fire or electric shock, do not expose this apparatus to rain or moisture.
16. Do not expose this equipment to dripping or splashing and ensure that no objects filled with liquids, such as vases, are placed on the equipment.
17. To completely disconnect this apparatus from the ac mains, disconnect the power supply cord plug from the ac receptacle.
18. The mains plug of the power supply cord shall remain readily operable.
19. This apparatus contains potentially lethal voltages. To prevent electric shock or hazard, do not remove the chassis, input module or ac input covers. No user serviceable parts inside. Refer servicing to qualified service personnel.
20. The loudspeakers covered by this manual are not intended for high moisture outdoor environments. Moisture can damage the speaker cone and surround and cause corrosion of electrical contacts and metal parts. Avoid exposing the speakers to direct moisture.
21. Keep loudspeakers out of extended or intense direct sunlight. The driver suspension will prematurely dry out and finished surfaces may be degraded by long-term exposure to intense ultra-violet (UV) light.
22. The loudspeakers can generate considerable energy. When placed on a slippery surface such as polished wood or linoleum, the speaker may move due to its acoustical energy output.
23. Precautions should be taken to assure that the speaker does not fall off a stage or table on which it is placed.
24. The loudspeakers are easily capable of generating sound pressure levels (SPL) sufficient to cause permanent hearing damage to performers, production crew and audience members. Caution should be taken to avoid prolonged exposure to SPL in excess of 90 dB.



This marking shown on the product or its literature, indicates that it should not be disposed with other household wastes at the end of its working life. To prevent possible harm to the environment or human health from uncontrolled waste disposal, please separate this from other types of wastes and recycle it responsibly to promote the sustainable reuse of material resources. Household users should contact either the retailer where they purchased this product, or their local government office, for details of where and how they can take this item for environmentally safe recycling. Business users should contact their supplier and check the terms and conditions of the purchase contract. This product should not be mixed with other commercial wastes for disposal.



## FEDERAL COMMUNICATIONS COMMISSION (FCC) STATEMENT

This equipment has been tested and found to comply with the limits for a Class A digital device, pursuant to part 15 of the FCC Rules. These limits are designed to provide reasonable protection against harmful interference when the equipment is operated in a commercial environment. This equipment generates, uses, and can radiate radio frequency energy and, if not installed and used in accordance with the instruction manual, may cause harmful interference to radio communications.

Operation of this equipment in a residential area is likely to cause harmful interference in which case the user will be required to correct the interference at their own expense.

This device complies with Part 15 of the FCC rules. Operation is subject to the following two conditions:

- (1) this device may not cause harmful interference, and
- (2) this device must accept any interference received, including interference that may cause undesired operation.

## DECLARATION OF CONFORMITY

**C E** The product is in compliance with:  
EMC Directive 2014/30/EU, LVD Directive 2014/35/EU, RoHS Directive 2011/65/EU and 2015/863/EU, WEEE Directive 2012/19/EU.

### EN 55032 (CISPR 32) STATEMENT

Warning: This equipment is compliant with Class A of CISPR 32. In a residential environment this equipment may cause radio interference. Under the EM disturbance, the ratio of signal-noise will be changed above 10 dB.

**UK CA** The product is in compliance with:  
S.I. 2016/1091 Electromagnetic Compatibility Regulations 2016, S.I. 2016/1101 Electrical Equipment (Safety) Regulations 2016, S.I. 2012/3032 The Restriction of the Use of Certain Hazardous Substances in Electrical and Electronic Equipment Regulations 2012.

### CISPR 32 STATEMENT

Warning: This equipment is compliant with Class A of CISPR 32. In a residential environment this equipment may cause radio interference. Under the EM disturbance, the ratio of signal-noise will be changed above 10 dB.

## LIMITED WARRANTY

Proel warrants all materials, workmanship and proper operation of this product for a period of two years from the original date of purchase. If any defects are found in the materials or workmanship or if the product fails to function properly during the applicable warranty period, the owner should inform about these defects the dealer or the distributor, providing receipt or invoice of date of purchase and defect detailed description. This warranty does not extend to damage resulting from improper installation, misuse, neglect or abuse. Proel S.p.A. will verify damage on returned units, and when the unit has been properly used and warranty is still valid, then the unit will be replaced or repaired. Proel S.p.A. is not responsible for any "direct damage" or "indirect damage" caused by product defectiveness.

- This unit package has been submitted to ISTA 1A integrity tests. We suggest you control the unit conditions immediately after unpacking it.
- If any damage is found, immediately advise the dealer. Keep all unit packaging parts to allow inspection.
- Proel is not responsible for any damage that occurs during shipment.
- Products are sold "delivered ex warehouse" and shipment is at charge and risk of the buyer.
- Possible damages to unit should be immediately notified to forwarder. Each complaint for package tampered with should be done within eight days from product receipt.

## CONDITIONS OF USE

Proel do not accept any liability for damage caused to third parties due to improper installation, use of non-original spare parts, lack of maintenance, tampering or improper use of this product, including disregard of acceptable and applicable safety standards. Proel strongly recommends that this loudspeaker cabinet be suspended taking into consideration all current National, Federal, State and Local regulations. The product must be installed by qualified personal. Please contact the manufacturer for further information.



## INDEX

INTRODUCTION	4
TECHNICAL SPECIFICATION	4
MECHANICAL DRAWING	5
OPTIONAL ACCESSORIES	5
SPARE PARTS	5
I/O AND CONTROL OPERATIONS	6
MAINS IN.	6
MAINS OUT.	6
FUSE HOLDER	6
INPUT	6
LINK	6
ON	6
PROT	6
SIGN/LIMIT	7
GND LIFT	7

NETWORK IN/OUT	7
TERMINATE	7
PRONET AX Network	8
EDITING USER PRESETS	10

## INTRODUCTION

The CX15AV2 is a coaxial stage monitor designed specifically for live sound, even if the low-profile enclosure is suitable also for theater and television applications. The high-performance coaxial transducer employed provides good sound balance and great intelligibility even at very high power.

The CX15AV2 is processed by 40 bit floating point CORE2 DSP and powered by a high efficiency CLASS D amplifier module with a newly designed power supply equipped with PFC, which reduces the power consumption while enhancing reliability and consistency in all operating conditions.

The high frequency range is reproduced by a low-distortion compression driver, equipped with pure Titanium diaphragm. An edgewound aluminum ribbon voice coil and a copper sleeve reduce distortion and increase the unit's output. The special shape of the cone allows a precise and controlled conical dispersion of 80°.

The 15" woofer employed in the reproduction of the low frequency range is equipped with a special interleaved sandwich 3" voice coil and an aluminum demodulation ring for minimum distortion. A single powerful neodymium magnet guarantees high performance with a consistent weight reduction.

## TECHNICAL SPECIFICATION

<b>SYSTEM</b>		Remote Control	PRONET AX control software
System's Acoustic Principle	2-way coaxial vented enclosure	Network protocol	CANBUS
Frequency response (-3 dB)	60 Hz – 18 kHz (Processed)	Amplifier Type	Class D amplifier with SMPS & PFC
Horizontal Coverage Angle	80° (-6 dB)	Output Power	2x 1400 W
Vertical Coverage Angle	80° (-6 dB)	Mains Voltage Range (Vac)	100 - 240 V~ ±10% 50/60 Hz
Maximum Peak SPL @ 1m	131 dB	Consumption*	700 W (nominal) 1700 W (max)
<b>TRANSDUCERS</b>		Mains Connector	PowerCon® (NAC3MPXXA)
Low frequency transducer	One 15" (380mm), 3" (75mm) Interleaved Voice Coil, 8 Ohm	Mains Link Connector	PowerCon® (NAC3MPXXB)
High frequency transducer	One 1.4" driver, 2.4" (60mm) edgewound aluminium voice coil, titanium diaphragm, 8 Ohm	IN / OUT Connectors	Neutrik XLR-M / XLR-F
<b>ELECTRICAL</b>		IN / OUT Network Connectors	ETHERCON® (NE8FAV)
Input Impedance	20 kΩ balanced	Cooling	Variable speed DC fan
Input Sensitivity	+4 dBu / 1.25 V	<b>ENCLOSURE &amp; CONSTRUCTION</b>	
Signal Processing	CORE2 processing, 40bit floating point SHARC DSP, 24 bit AD/DA converters	Width	520 mm (20.47")
Direct access Controls	4 Presets: Normal Wedge, Coupled Unit, Low Cut, User. Network Termination, GND Link	Height	336 mm (13.22")
		Depth	415 mm (16.33")
		Taper	Stage Monitor: 45° and 55°
		Pole holder	One on the side, dual-angle (0°/7.5°)
		Enclosure Material	15 mm, reinforced Phenolic Birch
		Paint	High resistance, water based paint
		Net Weight	18.5 Kg (40.8 lbs.)

\* Nominal consumption is measured with pink noise with a crest factor of 12 dB, this can be considered a standard music program.



## MECHANICAL DRAWING

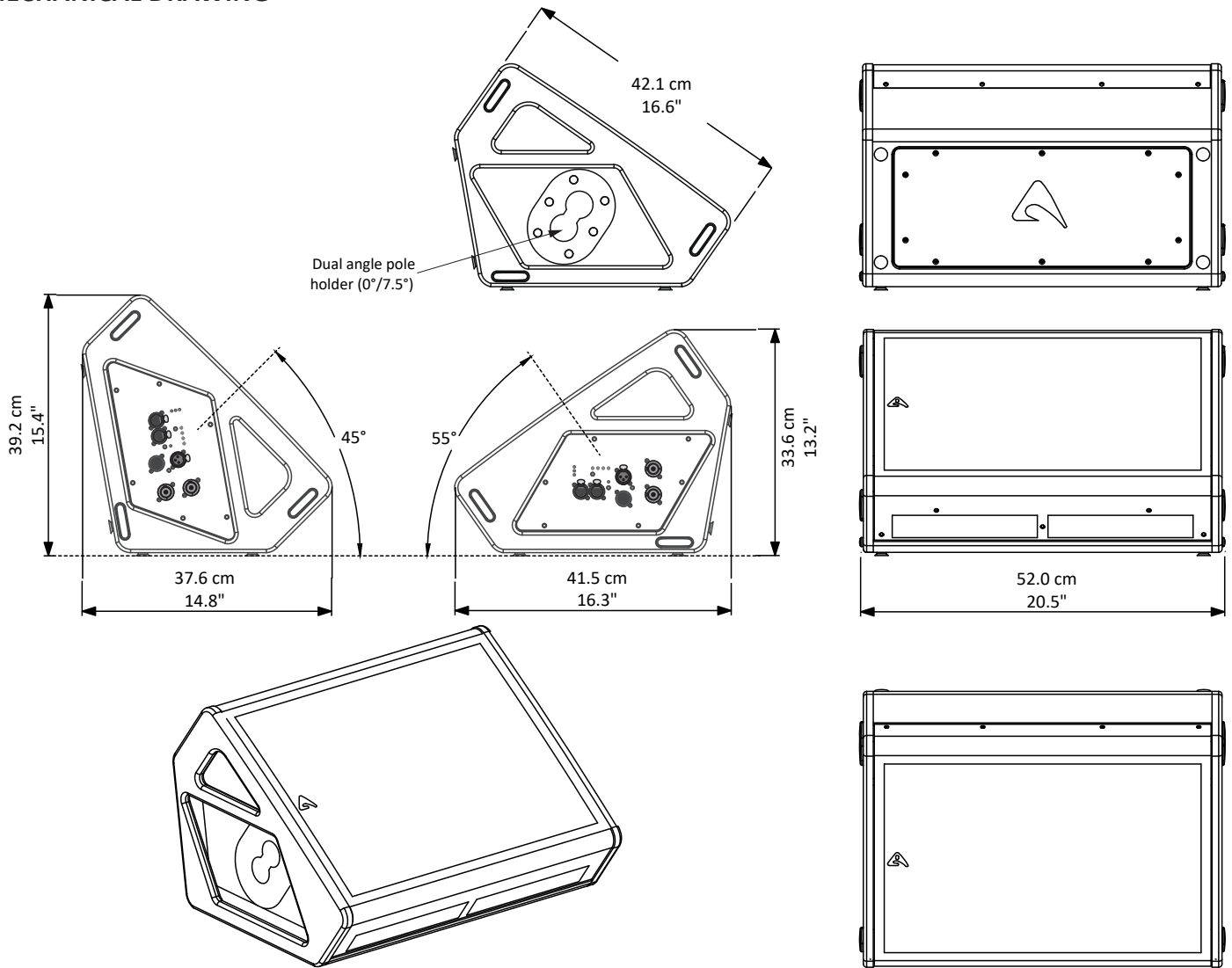

## OPTIONAL ACCESSORIES

<b>CXCASE02</b>	Carrying Case for 2 box unit	<b>CAT5SLU01/05/10</b>	1x Cat5e with NEUTRIK connectors, 1/5/10 m length
<b>NAC3FXXA-W-L</b>	Neutrik Powercon® BLUE PLUG	<b>AR100LUxx</b>	1x Cat6e - 1x Audio with NEUTRIK connectors various length
<b>NAC3FXXB-W-L</b>	Neutrik Powercon® WHITE PLUG	<b>AVCAT5PROxx</b>	Cat5e on cable drum, RJ45 plugs and NEUTRIK connectors 30/50/75 m length
<b>NE8MX-B-TOP</b>	Neutrik Ethercon PLUG		
<b>USB2CANDV2</b>	Dual output PRONET AX network converter		

see <http://www.axiomproaudio.com/> for detailed description and other available accessories.

## SPARE PARTS

<b>NAC3MPXXA</b>	Neutrik Powercon® BLUE SOCKET
<b>NAC3MPXXB</b>	Neutrik Powercon® WHITE SOCKET
<b>98NCX15WZ8</b>	Coaxial Loudspeaker 15" woofer - 1.4" driver
<b>98MBN1424T</b>	titanium diaphragm for 1.4" driver
<b>99CXRT15V</b>	Loudspeaker protection metal grid
<b>91DALITEMOD4HC</b>	POWERSOFT LITEMOD4HC amplifier module
<b>91DSPKT11</b>	Input, Control and CORE2 DSP PCBA



## I/O AND CONTROL OPERATIONS



### CX15A HIGH OUTPUT POWERED WEDGE MONITOR

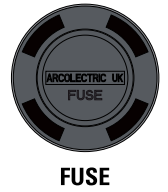
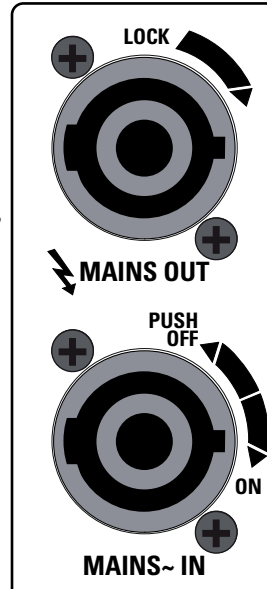
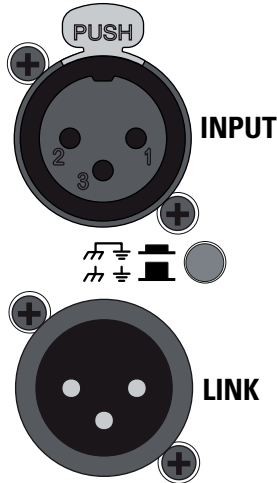
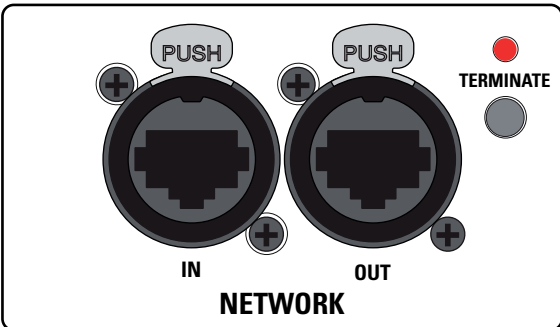
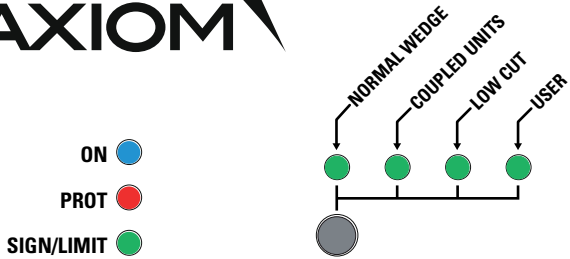

### MAINS IN

Powercon® NAC3FCA power input connector (blue). To switch the amplifier on, insert the Powercon® connector and turn it clockwise into the ON position. To switch the amplifier off, pull back the switch on the connector and turn it counter-clockwise into the POWER OFF position.

### MAINS OUT

Powercon® NAC3FCB power output connector (grey). This is connected in parallel with the MAINS ~ / IN. The maximum load applicable depends on the mains voltage. With 230V~ we suggest to link a maximum of 4 CX15AV2 loudspeakers, with 120V~ we suggest to link a maximum of 2 CX15AV2 loudspeaker.

### FUSE HOLDER

Here is where the mains protection fuse is placed.



#### WARNINGS:

- REPLACE THE PROTECTION FUSE ONLY WITH THE SAME TYPE: BUSSMANN MDA-15-R OR LITTELFUSE 326015.VX
- In the case of product failure or fuse replacement, disconnect the unit completely from the mains power.
- Use a suitable power cable and mains plug to build the power cable, it must only be connected to a socket corresponding to the specifications indicated on the amplifier unit. See assembly instruction downloadable from NEUTRIK WEB site at: <http://www.neutrik.com/>
- The power cable must only be connected to a socket corresponding to the specifications indicated on the amplifier unit.
- The power supply must be protected by a suitably rated thermo-magnetic breaker. Preferably use a suitable switch to power on the whole audio system leaving the Powercon® always connected to each speaker, this simple trick extend the life of the Powercon® connectors.
- Connect no more units to the MAINS OUT connector than as specified above.
- Turn on each unit one a time starting from the latest unit.

### INPUT

Audio signal input with locking XLR connector. It has a fully electronically balanced circuitry including AD conversion for the best S/N ratio and input headroom.

### LINK

A direct connection from the input connector to link other speakers with same audio signal.

### ON

This LED indicates power on status.

### PROT

This red LED lights when the amplifier module is in protect mode for an internal fault and, consequently, the amplifier is muted.



## SIGN/LIMIT

This LED lights in green to indicate the presence of the signal and lights in red when an internal limiter reduces the input level.

## GND LIFT

This switch lift the ground of the balanced audio inputs from the earth-ground of the amplifier module.

## NETWORK IN/OUT

These are a standard RJ45 CAT5 connectors (with optional NEUTRIK NE8MC RJ45 cable connector carrier), used for PRONET network transmission of remote control data over long distance or multiple unit applications.

## TERMINATE

In a PRONET network the last loudspeaker device must be terminated (with an inner load resistance) especially in a long run cabling: press this switch if you want to terminate the unit.

## PRESET BUTTON

This button has two function:

1) Pressing it while powering on the unit:

### ID ASSIGN

the internal DSP assigns a new ID to the unit for the PRONET AX remote control operation. Each loudspeaker must have a unique ID to be visible in the PRONET network. When you assign a new ID, all the other loudspeakers with the ID already assigned must be ON and connected to the network.

2) Pressing it with the unit ON you can select the DSP PRESET. The selected PRESET is indicated by the corresponding LED:

### NORMAL WEDGE

This PRESET is suitable for typical stage monitor applications. It can be used also when the CX15AV2 is used mounted on a pole.

### COUPLED UNITS

This preset provides the correct EQ when two CX15AV2 monitors, fed with the same audio signal, are placed at no more than 0,6 m (2 feet) one to the other. To be used for double stage monitoring for singers or other musicians.

### LOW CUT

This PRESET is the same as NORMAL WEDGE but with a low cut at 110 Hz 48 dB/oct. To be selected when a CX15AV2 is used in combination with a subwoofer to form a DRUM FILL or a SIDE FILL system. It can be used also in case you need to cut drastically the monitor LF response.

### USER

The USER PRESET corresponds to the first USER MEMORY (Preset 4-U) stored in the DSP and, as a factory setting, it's the same as NORMAL WEDGE. If you want to modify it, you have to connect the unit to a PC, edit the parameters with PRONET AX software and save it into "Preset 4-U-your\_preset\_name" (see also the PRONET AX manual).

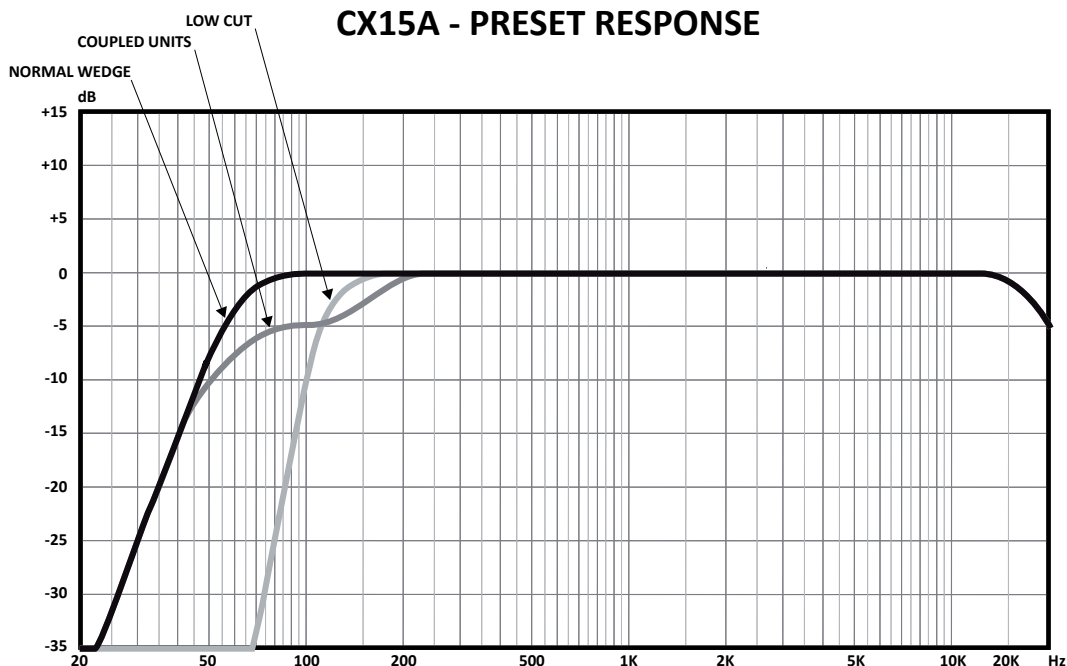



## PRONET AX Network

PRONET AX software has been developed in collaboration with sound engineers and sound designers, in order to offer an “easy-to-use” tool to setup and manage your audio system. With PRONET you can visualize signal levels, monitor internal status and edit all the parameters of each connected device.

Download the PRONET AX app registering on MY AXIOM at the website at <https://www.axiomproaudio.com/>.

The AXIOM active loudspeaker devices can be connected in a network and controlled by the PRONET AX software. For the network connection the PROEL **USB2CAND** (with 2-port) converter optional accessory is needed.

PRONET AX network is based on a “bus-topology” connection, where the first device is connected to the input connector of the second device, the second device network output is connected to the network input connector of the third device, and so on. To ensure a reliable communication the first and the last device of the “bus-topology” connection must be terminated. This can be done by pressing the “TERMINATE” switch near the network connectors in the rear panel of the first and the last device. For the network connections simple RJ45 cat.5 or cat.6 ethernet cables can be used (please don’t confuse a ethernet network with a PRONET AX network these are completely different and must be fully separated also both use the same kind of cable).

## EXAMPLE OF PRONET NETWORK WITH CX15A WEDGE MONITOR

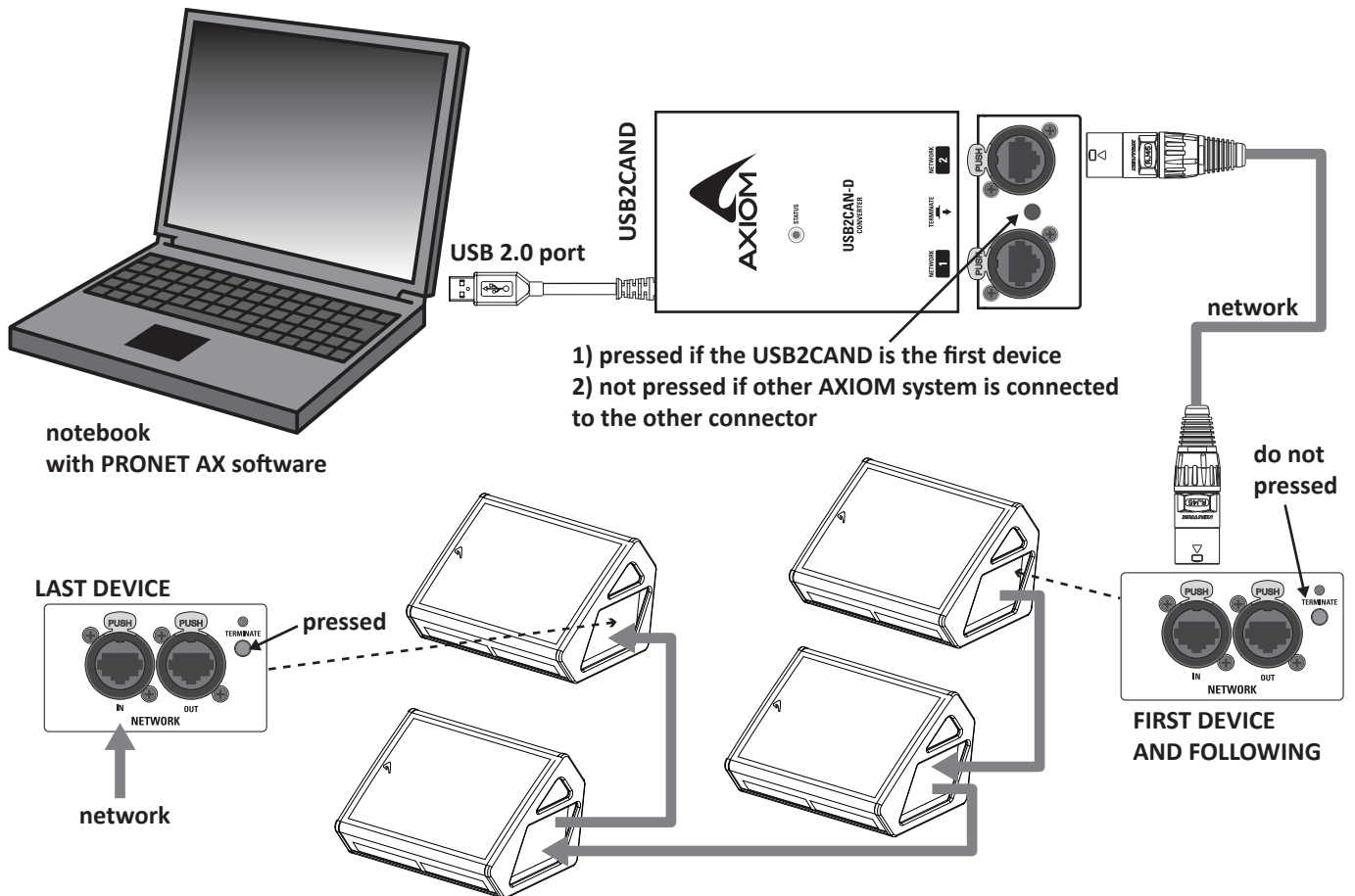





### **Assign the ID number**

To work properly in a PRONET AX network each connected device must have a unique identifier number, called ID. By default the USB2CAND PC controller has ID=0 and there can be only one PC controller. Every other device connected must have its own unique ID equal or greater than 1: in the network cannot exist two devices with the same ID.

In order to correctly assign a new available ID to each device for working properly in a Pronet AX network, follow these instructions:

1. Switch off all the devices.
2. Connect them correctly to the network cables.
3. "TERMINATE" the end device in the network connection.
4. Switch on the first device keep pressed "PRESET" button on the control panel.
5. Leaving the previous device switched on, repeat the previous operation on the next device, until the latest device is turned on.

The "Assign ID" procedure for a device makes the internal network controller to perform two operations: reset the current ID; search the first free ID in the network, starting from ID=1. If no other devices are connected (and powered on), the controller assume ID=1, that is the first free ID, otherwise it searches the next one left free.

These operations ensure that every device has it's own unique ID, if you need to add a new device to the network you simply repeat the operation of step 4. Every device maintains its ID also when it is turned-off, because the identifier is stored in the internal memory and it is cleared only by another "Assign ID" step, as explained above.



**With the network made always of the same devices the assigning ID procedure must be executed only the first time the system is turned on.**



## EDITING USER PRESETS

If you connect the CX15AV2 stage monitor to a PC, using PRONET AX Control Software you can edit the user presets. Here below a typical stage setup of a band using 8 CX15AV2 wedges from a monitor engineer point of view:

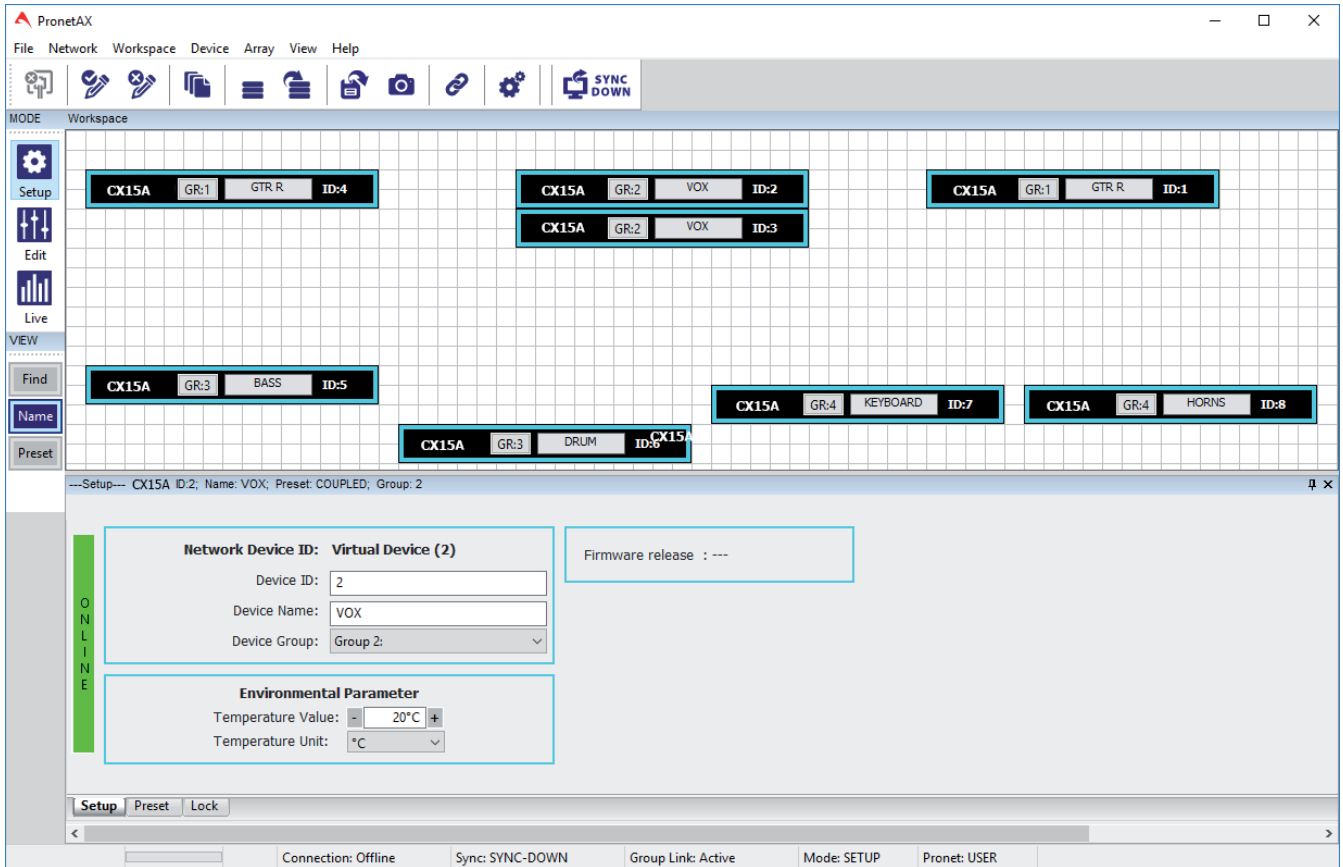

**Setup - Device Name:** here you can assign a unique name at the unit (twelve characters are available).

**Setup - Device Group:** here you assign the unit to a group, so when the LINK function on PRONET software is activated, you can automatically set the same parameters to all the units assigned to the same group.

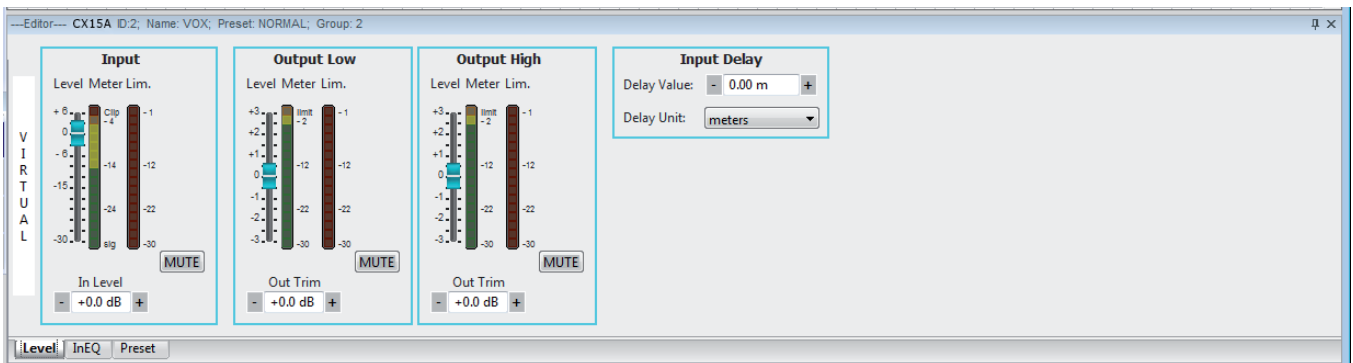

For each unit is possible to edit its DSP parameters, a brief explanation will follow:

**Input - Level:** adjusts the input level gain in the range of  $-30 \div +6$  dB (this is a digital control after the A/D converter).

**Input - Meter:** shows the input level signal after the A/D converter in dBFs. Green LED indicates the normal operating level before nominal input sensitivity ( $+4$  dBu corresponding to  $-16$  dBFs), yellow LED indicates that the signal exceeds the nominal sensitivity, red LED indicates digital clipping and must be avoided.

**Input - Limiter:** show the reduction of the input signal if it crosses the threshold of the input limiter for the whole loudspeaker, this value is set from factory for the better performance and transparency.

**Input/Output - MUTE:** these buttons can be used to switch off the unit or the woofer or the HF driver in order to check the system.

**Output - Out Trim:** use these controls in you want to trim finely the level of woofer and HF driver within a  $\pm 3$  dB range.

**Output - Limiter:** show the reduction of the signal sent to each speaker, the threshold of these limiters is set from factory to preserve the safety of each speaker.

**Input - Delay:** edit this box to apply a delay to the speaker, to be used typically if you need to align in time the speaker to another





sound source. **Note:** a delay higher than 10 ms (3 m) is easily audible and it can be annoying to singers and musicians.

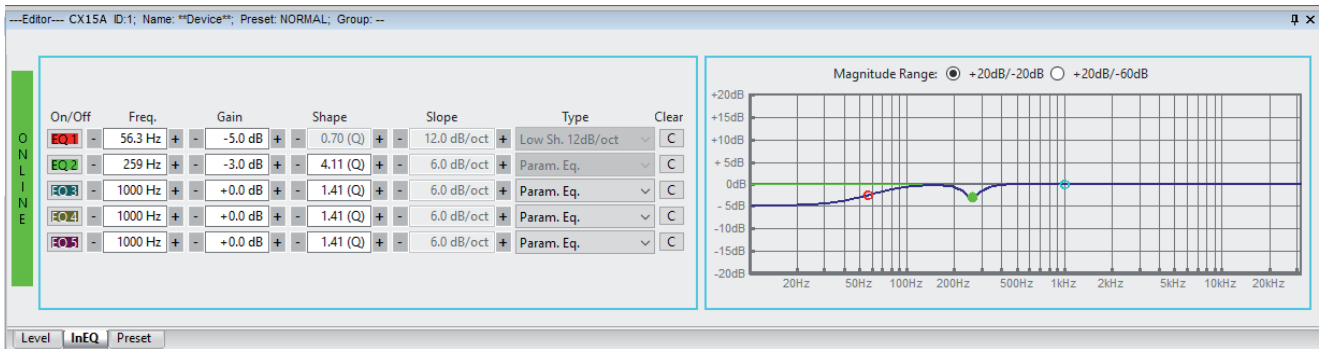

**PEQ - EQ1-5:** 5-band full parametric EQ.

**Note:** CX15AV2 is already optimized for the best performance for wedge monitoring, so we suggest to make only small adjustments to adjust the response for particular environments or instrument mic'ing.

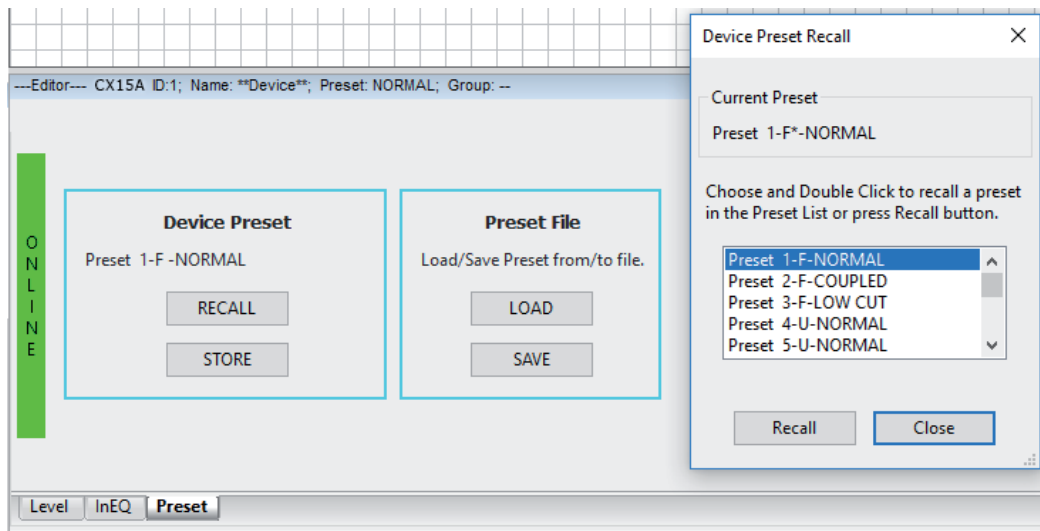

**PRESET:** you can store or recall preset in the device's memory or load and save presets in your computer HD as \*.pcf files.

**Note:** the user preset no. 4-U can be reloaded also from the unit's control panel without the need to re-connect to the pc.

For more detailed instruction about PRONET AX see the **USER'S MANUAL** included with the software.



**PROEL S.p.A. (World Headquarters) - Via alla Ruenia 37/43 - 64027 Sant'Omero (Te) - ITALY**  
**Tel: +39 0861 81241 Fax: +39 0861 887862 [www.axiomproaudio.com](http://www.axiomproaudio.com)**

