

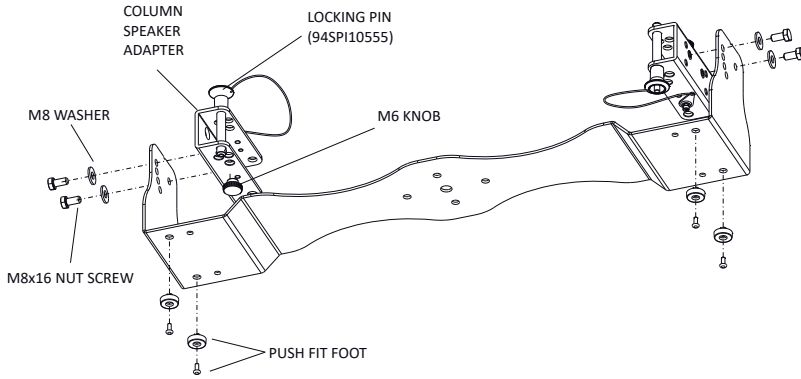

AX8CL FLOOR/FRONT FILL, SIDE WALL, CEILING/UNDER BALCONY BRACKET

CODE: KPTWAX8CL
Assembly Instructions

SUPPLIED MATERIALS



DIMENSIONS and DRILLING

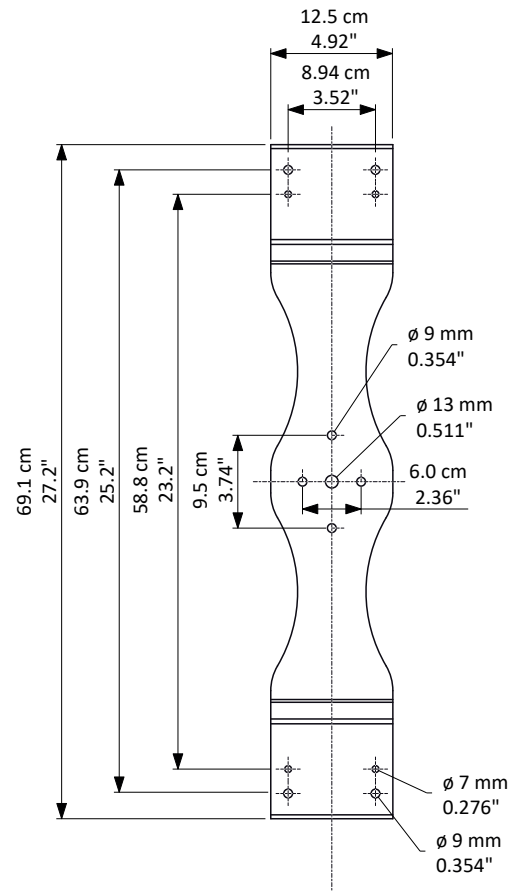

LOCKING PIN INSERTION

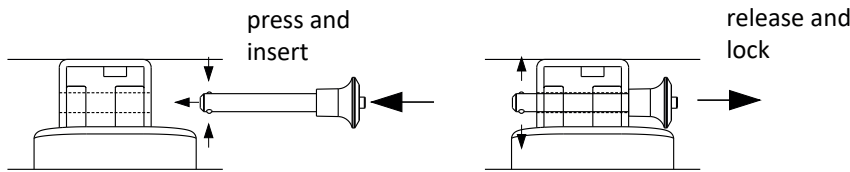

on floor/front fill/stage monitor

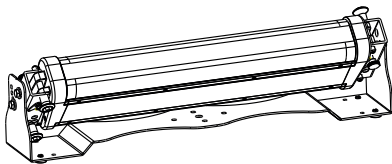

0° +45° (12.5° 4 step)

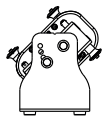

on side wall (horizontally)

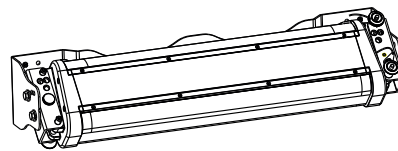

-45° -90° (12.5° 4 step)

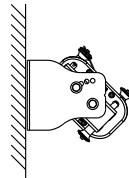

on ceiling/under balcony

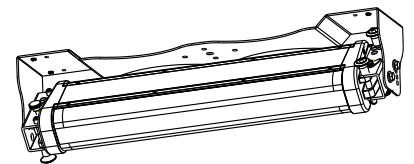

0° -45° (12.5° 4 step)

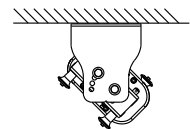

CONDITIONS OF USE

Proel do not accept any liability for damage caused to third parties due to improper installation, use of non-original spare parts, lack of maintenance, tampering or improper use of this product, including disregard of acceptable and applicable safety standards. Proel strongly recommends that this loudspeaker cabinet be suspended taking into consideration all current National, Federal, State and Local regulations. The product must be installed by qualified personnel only. Please contact the manufacturer for further information.



WARNINGS:

- KPTWAX8CL can be used in front-fill or monitor applications on stage and in under-balcony or side wall installations in theatres or conference rooms.
- Brackets MUST be installed by qualified personnel in accordance with safe installation practices.
- The ground where the KPTWAX8CL C-bracket is placed needs to be stable and compact.
- Whend using this support for front fill applications, place it on a stable surface. If it is placed on a front line subwoofer, it must be secured to it using a strap, because the subwoofer vibrations could cause it to fall to ground.

This drawing is the exclusive property of PROEL S.p.A. and cannot be reproduced without prior authorization.