

# Angekis®

## FHD PTZ Camera

### Saber IP20X NDI

NDI|HX

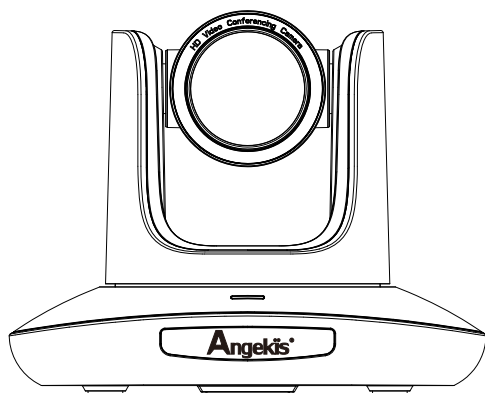

User Manual v2.0 EN

Please refer this document before using.

# CONTENT

SAFETY GUIDES.....	2
PACKING LIST.....	3
QUICK START.....	3
PRODUCT HIGHLIGHTS.....	4
TECHNICAL SPEC.....	5
CAMERA INTERFACE.....	7
CAMERA DIMENSION(mm).....	7
IR REMOTE CONTROLLER.....	8
VISCA IN ( RS232 PORT ).....	10
VISCA NETWORK CONSTRUCTION.....	10
SERIAL PORT CONFIGURATION.....	11
VISCA PROTOCOL.....	11
PELCO-D PROTOCOL LIST.....	21
PELCO-P PROTOCOL COMMAND LIST.....	22
OSD MENU.....	23
UVC CONTROL.....	27
WEB SETTING.....	28
USING VCL TO VIEW RTSP VIDEO.....	36
VISCA OVER IP.....	37

# SAFETY GUIDES

1. Before operation, please fully read and follow all instructions in the manual. For your safety, always keep this manual with the camera.
2. The camera power input range is 100-240VAC(50-60Hz), ensure the power supply input within this rate before powering on.
3. The camera power voltage is 12VDC, rated current is 2A. We suggest you use it with the original power supply adapter supplied by the factory.
4. Please keep the power cable, video cable and control cable in a safe place. Protect all cables especially the connectors.
5. Operational environment: 0°C-50°C, humidity less than 90%. To avoid any danger, do not put anything inside the camera, and keep away from the corrosive liquid.
6. Avoid stress, vibration and damp during transportation, storage and installation.
7. Do not touch the camera housing and cover. For any service, please contact authorized technicians.
8. Video cable and control cable should be individually shielded, and cannot be substituted with other cables. Do not direct the camera lens towards strong light, such as the sun or the intensive light.
9. Use a dry and soft cloth to clean the camera housing. Applied with neutral cleaning agent when there is need to clean. To avoid damage on the camera lens, never use strong or abrasive cleaning agents on the camera housing.
10. Do not move the camera by holding the camera head. To avoid mechanical trouble, do not rotate the camera head by hand. NEVER MOVE THE CAMERA MANUALLY WHEN IT IS WORKING.
11. Put the camera on fixed and smooth desk or platform, avoid leaned installation.
12. Power Supply Polarity (Drawing)



Note:  
The video quality may be affected by the specific frequencies of electromagnetic field.  
Never grasp the head of the camera, and never move the camera by hand when it is working, otherwise, mechanism maybe destroyed.

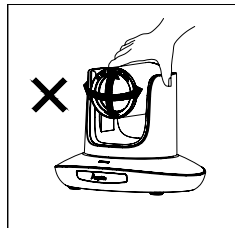
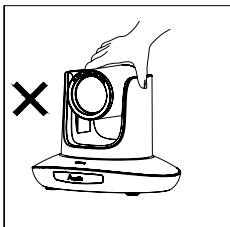

# PACKING LIST

Check all bellow items when open the package:

Camera	-----	1 PCS
Power Adapter	-----	1 PCS
Power Cable	-----	1 PCS
RS232 Control Cable	-----	1 PCS
USB3.0 Cable	-----	1 PCS
Remote Controller	-----	1 PCS
User Manual	-----	1 PCS
Double-sided Adhesive	-----	1 PCS
QC certification	-----	1 PCS

# QUICK START

1. Check all cable connections before power on.

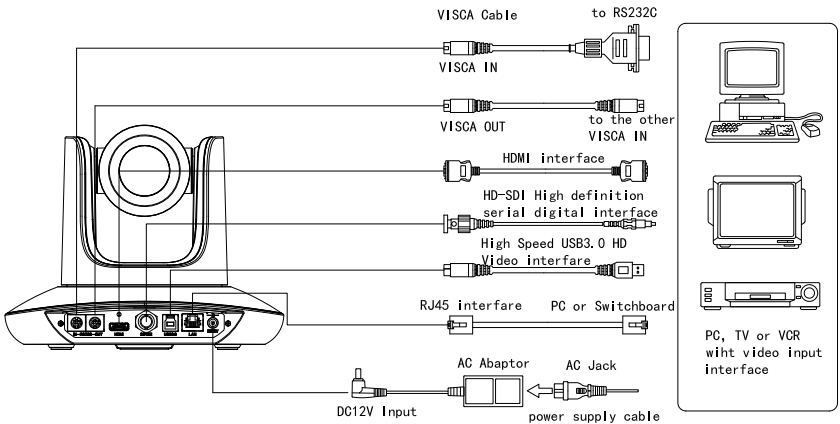



Dial Switch Setting (at the bottom of the camera):

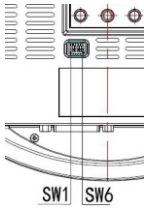

Dial Switch ( ARM )			
	SW-1	SW-2	Instruction
1	OFF	OFF	Updating mode
2	ON	OFF	Debugging mode
3	OFF	ON	Undefined
4	ON	ON	Working mode

Dial Switch			
	SW-3	SW-4	Instruction
1	OFF	OFF	reserve
2	ON	OFF	reserve
3	OFF	ON	reserve
4	ON	ON	reserve

Dial Switch ( USB )			
	SW-5	SW-6	Instruction
1	OFF	OFF	Undefined
2	ON	OFF	Working mode
3	OFF	ON	Updating mode
4	ON	ON	Undefined

## PRODUCT HIGHLIGHTS

- 1/2.8 inch 2.4MP CMOS sensor, 1080p Video
- High end 20x optical zoom, 2x digital zoom lens with 60 degree field of view.
- IP, HDMI, 3G-SDI, USB outputs, fit for different application
- White Balance, Exposure, Focus, Iris can be adjusted automatically or manually.
- Support POE: one single CAT5/6 to get video, control and power supply;
- Special Focusing Algorithm: fast and precise focusing performance when zooming or moving,
- Smooth PTZ mechanical design, accurate pan tilt motor control;
- 128 presets supported; Exposure parameter and white balance parameter can be saved in presets (in manual mode)
- Standard Sony VISCA, IP VISCA, PELCO-P, PELCO-D control protocol; IP VISCA over both TCP and UDP.
- Daisy chain supported, max 7 cameras connected in VISCA protocol.
- Image flip function, support upside-down installation;
- Supplied with functional IR remote controller, can set IP address via OSD menu;
- Fast video format switch: less than 3 seconds
- Supported field upgrade for ISP, ARM, FPGA and USB
- USB3.0 port compatible with USB2.0 output.
- Support RS232/RS485/UVC control
- NDI H|X IP streaming protocol

- Standard UVC1.5 protocol, seamlessly compatible with major video conferencing software and platform
- Support IR transfer function, code of the third party remote controller can be transferred to the host via VISCA IN port, in case client's development.
- OSD menu in English and Chinese supported. IP address, streaming resolution and size can be set in OSD menu.

## TECHNICAL SPEC

Video Format	HDMI (V1.4)	1920*1080P60/50/30/25/59.94/29.97/24
		1920*1080I60/50/59.94
		1280*720P60/50/30/25/59.94/29.97
	SDI	1920*1080P60/50/30/25/59.94/29.97/24
		1920*1080I60/50/59.94
		1280*720P60/50/30/25/59.94/29.97
	USB	1920*1080P60/50/30/25 ( USB3.0 )
		1280*720P60/50/30 ( USB3.0 )
		1280*720P25 ( USB3.0&USB2.0 )
		1024*576P30 ( USB3.0&USB2.0 )
		960*540P30 ( USB2.0 )
		640*360P30 ( USB2.0 )
		512*288P30 ( USB2.0 )
	RJ45	1920*1080@1~30 ( Main Stream )
		1280*720@1~30 / 1024*576@1~30 / 640*360@1~30 ( Sub stream )
NDI	1920*1080 @ 3~60fps; 1280*720 @ 3~60fps; 1024*576 @ 3~60fps; 640*360 @ 30fps (lowbroadbandmode)	
Video Interface	HDMI (V1.4), SDI, NDI HX, USB3.0 (Compatible with USB2.0)	
Sensor	1/2.8 inch 2.4MP CMOS sensor	
Zoom	f4.9 ~ 98mm(20x), F1.5 - 3.0, ViewAngle: 60°(Far)-3.2°(Near)	
Rotation Angle	Pan: -170° ~ +170°;      Tilt: -30° ~ +90°	

Rotation Speed	Pan: 0°~120°/s ;                      Tilt: 0°~80°/s
Preset:	Remote controller: 10; RS232: 128; Accuracy: 0.1°
Control Port	RS232, RS485 (Serial Visca, Pelco-P/D), RJ45 (VISCA over IP), USB3.0 (UVC1.5), USB2.0 (UVC1.1)
Network Speed	1000M
Video encode	H.264/H.265(default: H.264)
Bit Rate Control	Variable Bit Rate, Constant Bit Rate
Video Bit Rate	0Kbps~15360Kbps
IP Protocol	TCP/IP, HTTP, DHCP, RTSP, RTMP, Onvif 2.4, VISCA over IP (TCP&UDP), NDI (H/X), SRT Compatible
POE	Supported
Daisy Chain	Support RS232 serial daisy chain
Minimum Lux	0.01lux
White Balance	Auto/Indoor/Outdoor/Manual/Outauto/Sodium Lamp Auto/Sodium Lamp
Exposure	Auto/Manual/Bright/Shutter/Iris
Focus	Auto / Manual
Iris	Auto / Manual
Electric Shutter	Auto / Manual
Gamma	Supported
WDR	Supported
BLC	Supported
2D Noise Reduction	Supported
3D Noise Reduction	Supported
Anti Flicker	OFF/50Hz/60Hz
PanTilt Flip	Supported

Input Voltage	DC12V/POE
Dimension	220mm×190mm×173mm
Net Weight	1.8KG (3.98LBS)

## CAMERA INTERFACE

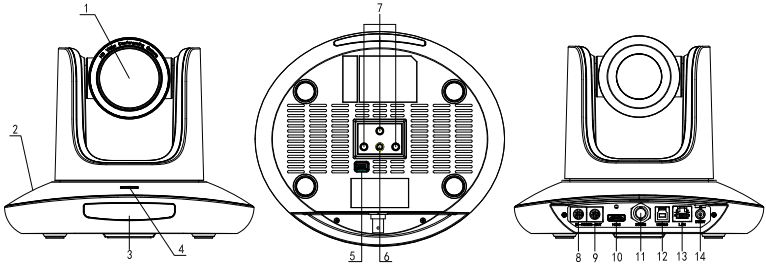

- 1.Camera Lens
- 2.Camera Base
- 3.IR Receiver Panel
- 4.Power Indicator Light
- 5.Dial Switch

6. Tripod Screw Hole
7. Installation Hole
8. RS232 control port (input)
9. RS232 control port(output)

10. HDMI port
- 11.3G-SDI port
12. USB port
13. RJ45 port (NDI|HX)
14. DC12V plug

## CAMERA DIMENSION(MM)

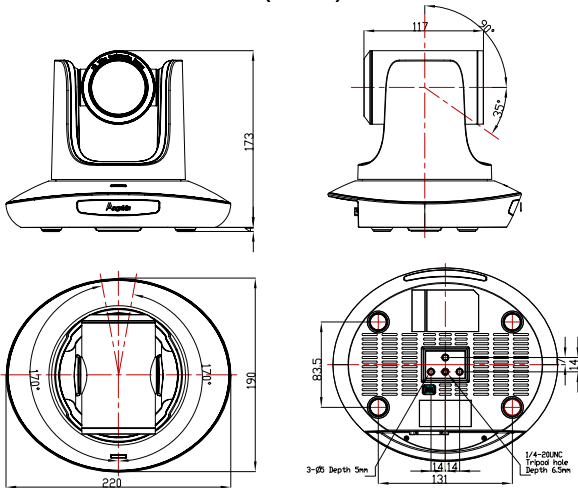

# IR REMOTE CONTROLLER



### Video mute

Short press Video mute button to turn off the camera and short press again to turn it on.

### Power Key

Under normal working mode, short press Power key to let the camera enter standby mode; Press it again, the camera will do self-configuration and then go back to HOME position; It will go to preset position if the power on mode has been set.



### Address/Camera Setting Key

Set+(Cam1~Cam4): set camera's remote control address. Short press Cam1~Cam4 to select the camera

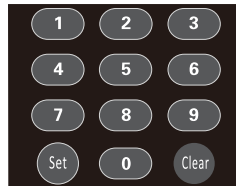

### Number Key

Set Presets: Set+(0~9) to set preset.

Recall Presets: Short press the(0~9)number key to recall presets.

### Clear Key

Clear+(0~9): to clear the relative preset;

Long press to clear all preset.

**Menu Key****Ok:** to confirm the menu selection**Menu:** enter/exit menu**Back:** back to previous menu**F+/F-:**

Set focus by manual, only valid under manual focus mode.

**T/W:**

Set the lens zoom rate.

**Navigate Key: Up/Down/Left/Right**

Under normal working mode, use navigate key to set the pan tilt, and select values when enter OSD.

**Home Key:**

Under normal working mode, short press Home key to let the camera go back to home position.

**Flip:** Enable/Disable the picture up/down flip;**Mir:** Enable/Disable the picture left/right flip;**MF:** Enable manual focus model;**AF:** Enable manual focus model.**SHARP:** Set sharpness level;**NR+/-:** Set noise reduction level;**Reset:** Long press(3S) to reset camera;**Rev:** Display camera revision;

Note: under specific environment, due to heavy infrared interfere, (such as if put the camera on a big infrared touch screen, or if there is a strong iodine-tungsten lamp in the room), it may affect the infrared remote receiver performance, which may cause wrong control/movement. In this case, if the user doesn't need to use the remote controller, we suggest to dial the SW3-4 to OFF, to close the infrared signal receiving.

# VISCA IN ( RS232 PORT )

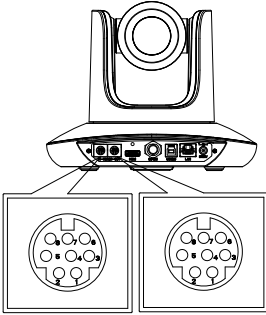

No.	Function
1	DTR
2	DSR
3	TXD
4	GND
5	RXD
6	A
7	IR OUT
8	B

VISCA IN	RS485
1	
2	
3	
4	
5	
6	A(+)
7	IR OUT
8	B(-)

VISCA IN & Mini DIN Connection

Camera VISCA IN		Mini DIN	
1	DTR	1	DSR
2	DSR	2	DTR
3	TXD	5	RXD
4	GND	4	GND
5	RXD	3	TXD
6	A(+)	6	NC
7	IR OUT	7	NC
8	B(-)	8	NC

VISCA IN & DB9 Connection

Camera VISCA IN		Windows DB-9	
1	DTR	6	DSR
2	DSR	4	DTR
3	TXD	2	RXD
4	GND	5	GND
5	RXD	3	TXD
6	A(+)		
7	IR OUT		
8	B(-)		

# VISCA NETWORK CONSTRUCTION:

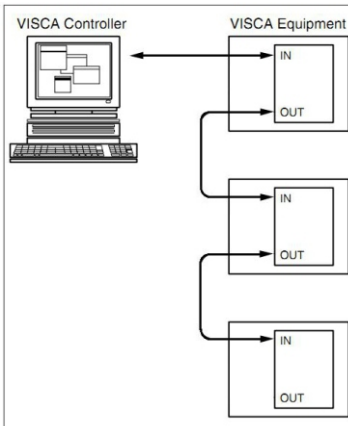

# SERIAL PORT CONFIGURATION

Parameter	Value	Parameter	Value
Baud rate	2400/4800/9600/115200	Stop Bit	1bit
Start Bit	1 bit	Check Bit	None
Date Bit	8 bit		

## VISCA PROTOCOL

### Part1 Camera Return Command

Ack/Completion Message		
	Command Packet	Note
ACK	z0 41 FF	Returned when the command is accepted.
Completion	z0 51 FF	Returned when the command has been executed.

z = camera addresss+8

Error Messages		
	Command Packet	Note
Syntax Error	z0 60 02 FF	Returned when the command format is different or when a command with illegal command parameters is accepted
Command Not Executable	z0 61 41 FF	Returned when a command cannot be executed due to current conditions. For example, when commands controlling the focus manually are received during auto focus.

### Part 2 Camera Control Command

Command type	function	Command packet	Note	
AddressSet	Broadcast	88 30 01 FF	Address setting	
IF_Clear	Broadcast	88 01 00 01 FF	I/F Clear	
CommandCancel		8x 21 FF		
CAM_Power	On	8x 01 04 00 02 FF	Power ON/OFF	
	Off	8x 01 04 00 03 FF		
CAM_Zoom	Stop	8x 01 04 07 00 FF	p = 0(low)~7(high)	
	Tele(Standard)	8x 01 04 07 02 FF		
	Wide(Standard)	8x 01 04 07 03 FF		
	Tele(Variable)	8x 01 04 07 2p FF		
	Wide(Variable)	8x 01 04 07 3p FF		
	Direct	8x 01 04 47 0p 0q 0r 0s FF		pqrs: Zoom Position (0(wide)~0x4000(tele))
	Direct with speed	8x 0A 04 47 0t 0p 0q 0r 0s FF		t: spd 0~7 pqrs: Zoom Position (0(wide)~0x4000(tele))
CAM_DZoom	ON	8x 01 04 06 02 FF	Combine with optical zoom control	
	OFF	8x 01 04 06 03 FF		
	Combine Mode	81 01 04 36 00 FF		



Command type	function	Command packet	Note
	Separate Mode	81 01 04 36 01 FF	Separate with optical zoom control
	Stop	81 01 04 06 00 FF	Enable In separate mode
	Tele (Variable)	81 01 04 06 2p FF	Enable In separate mode
	Wide (Variable)	81 01 04 06 3p FF	Enable In separate mode
	Direct	81 01 04 46 0p 0q 0r 0s FF	Enable In separate mode
CAM_Focus	Stop	8x 01 04 08 00 FF	
	Far(Standard)	8x 01 04 08 02 FF	
	Near(Standard)	8x 01 04 08 03 FF	
	Far (Variable)	81 01 04 08 2p FF	p=0 (Low) to 7 (High)
	Near (Variable)	81 01 04 08 3p FF	p=0 (Low) to 7 (High)
	Direct	8x 01 04 48 0p 0q 0r 0s FF	pqrs: Focus Position
	Auto Focus	81 01 04 38 02 FF	
	Manual Focus	81 01 04 38 03 FF	
	One Push AF	8x 01 04 18 01 FF	
CAM_ZoomFocus	Direct	8x 01 04 47 0p 0q 0r 0s 0t 0u 0v 0w FF	pqrs: Zoom Position (0(wide)~ 0x4000(tele)) tuvv: Focus Position
CAM_WB	Auto	8x 01 04 35 00 FF	
	Indoor	8x 01 04 35 01 FF	
	Outdoor	8x 01 04 35 02 FF	
	OnePush	8x 01 04 35 03 FF	
	ATW	8x 01 04 35 04 FF	
	Manual	8x 01 04 35 05 FF	
	Sodium lamp	8x 01 04 35 08 FF	
	fluorescent	8x 01 04 35 09 FF	
	OnePush Trigger	8x 01 04 10 05 FF	
CAM_RGain	Reset	8x 01 04 03 00 FF	Manual Control of R Gain
	Up	8x 01 04 03 02 FF	
	Down	8x 01 04 03 03 FF	
	Direct	8x 01 04 43 00 00 0p 0q FF	pq: R Gain (0~0xFF)
CAM_Bgain	Reset	8x 01 04 04 00 FF	Manual Control of B Gain

Command type	function	Command packet	Note
	Up	8x 01 04 04 02 FF	
	Down	8x 01 04 04 03 FF	
	Direct	8x 01 04 44 00 00 0p 0q FF	pq: B Gain (0-0xFF)
CAM_AE	Full Auto	81 01 04 39 00 FF	Automatic Exposure mode
	Manual	81 01 04 39 03 FF	Manual Control mode
	Shutter Priority	81 01 04 39 0A FF	Shutter Priority Automatic Exposure mode
	Iris Priority	81 01 04 39 0B FF	Iris Priority Automatic Exposure mode
	Bright	81 01 04 39 0D FF	Bright Mode (Manual control)
CAM_Shutter	Reset	8x 01 04 0A 00 FF	Shutter Setting
	Up	8x 01 04 0A 02 FF	
	Down	8x 01 04 0A 03 FF	
	Direct	8x 01 04 4A 00 00 0p 0q FF	pq: Shutter Position (0~0x15)
CAM_Iris	Reset	8x 01 04 0B 00 FF	Iris Setting(0~0xD)
	Up	8x 01 04 0B 02 FF	
	Down	8x 01 04 0B 03 FF	
	Direct	8x 01 04 4B 00 00 0p 0q FF	pq: Iris Position (0~ 0x11)
CAM_Gain	Reset	8x 01 04 0C 00 FF	Gain Setting (0~0x0F)
	Up	8x 01 04 0C 02 FF	
	Down	8x 01 04 0C 03 FF	
	Direct	8x 01 04 0C 00 00 0p 0q FF	pq: Gain Positon (0~0x0E)
CAM_Bright	Reset	8x 01 04 0D 00 FF	Bright Setting
	Up	8x 01 04 0D 02 FF	
	Down	8x 01 04 0D 03 FF	
	Direct	8x 01 04 4D 00 00 0p 0q FF	pq: Bright I Positon (0~0x1B)
CAM_WDR	On	8x 01 04 3D 02 FF	Exposure Compensation ON/OFF
	Off	8x 01 04 3D 03 FF	
	Direct	8x 01 04 2D pq FF	pq: ExpComp Position (0~0x6)

Command type	function	Command packet	Note
CAM_BackLight(BLC)	On	8x 01 04 33 02 FF	BackLight On
	Off	8x 01 04 33 03 FF	BackLight Off
CAM_Sharpness	Reset	8x 01 04 02 00 FF	Aperture Control
	Up	8x 01 04 02 02 FF	
	Down	8x 01 04 02 03 FF	
	Direct	8x 01 04 42 00 00 0p 0q FF	pq: Aperture Gain (0~0x0F)
CAM_Memory(preset)	Reset	8x 01 04 3F 00 0p FF	p: Preset Number(=0 to 127) Corresponds to 0 to 9 on the Remote Commander
	Set	8x 01 04 3F 01 0p FF	
	Recall	8x 01 04 3F 02 0p FF	
CAM_LR_Reverse	On	8x 01 04 61 02 FF	Image Flip Horizontal ON/OFF
	Off	8x 01 04 61 03 FF	
CAM_PictureFlip	On	8x 01 04 66 02 FF	Image Flip Vertical ON/OFF
	Off	8x 01 04 66 03 FF	
CAM_RS485Ctl	On	8x 01 06 A5 02 FF	
	Off	8x 01 06 A5 03 FF	
CAM_Saturation	Saturation	8x 01 04 A1 00 00 0p 0q FF	pq :saturation level 0x00~0xff
CAM_Contrast	Contrast	8x 01 04 A2 00 00 0p 0q FF	pq :Contrast level 0x00~0xff
CAM_SpeedByZoom	On	8x 01 06 A0 02 FF	
	Off	8x 01 06 A0 03 FF	
CAM_PTSpeed	PT Speed	8x 01 04 C1 00 00 0p 0q FF	pq :PT speed 0x05~0x18
CAM_ZoomSpeed	Zoom Speed	8x 01 04 D1 00 00 0p 0q FF	pq :Zoom speed 0x01~0x07
CAM_ZoomDisplay	On	8x 01 06 C2 02 FF	
	Off	8x 01 06 C2 03 FF	
CAM_IRAddress	IR address	8x 01 06 D8 0p FF	p:IR address 1~4
CAM_Gamma	Gamma set	81 01 04 5B 0p FF	P:Gamma NO. (0~4)
CAM_MountMode	UP	8x 01 04 A4 02 FF	Mount Up
	Down	8x 01 04 A4 03 FF	Mount Down
CAM_ColorGain	Direct	8x 01 04 49 00 00 00 0p FF	(0~0x0E)
CAM_2D Noise Reduction	Direct	8x 01 04 53 0p FF	(0~0x05)
CAM_3D Noise Reduction	Direct	8x 01 04 54 0p FF	(0~0x03)

Command type	function	Command packet	Note
FLICK	50HZ	81 01 04 23 01 FF	
	60HZ	81 01 04 23 02 FF	
	OFF	81 01 04 23 00 FF	
VideoSystem Set(Telycam)		8x 01 06 35 00 pp FF	pp: Video format 1080P60 0x00 1080P50 0x01 1080I60 0x02 1080I50 0x03 1080P30 0x 04 1080P25 0x05 720P60 0x 06 720P50 0x07 720P30 0x08 720P25 0x09 1080P5994 0x0E 1080I5994 0x0F 1080P2997 0x10 720P5994 0x13 720P2997 0x14 1080P24 0x11 1080P2398 0x12
VideoSystem Set(Sony)		81 01 04 24 72 0p 0q FF	pq: Video format 1080P60 0x2e 1080P50 0x2f 1080I60 0x01 1080I50 0x04 1080P30 0x06 1080P25 0x08 720P60 0x09 720P50 0x0c 720P30 0x0e 720P25 0x11 1080P5994 0x13 1080I5994 0x02 1080P2997 0x07 720P5994 0x0a 720P2997 0x0f 1080P24 0x2a 1080P2398 0x2b
CAM_IDWrite		8x 01 04 22 0p 0q 0r 0s FF	pqrs: Camera ID (=0000 to FFFF)
DHCP control	DHCP off	8x 01 04 AE 00 FF	DHCP off
	DHCP on	8x 01 04 AE 01 FF	DHCP on

Command type	function	Command packet	Note
Mainstream	resolution	8x 01 04 C2 00 0p 0q 0r 0s 0m 0n 0x 0y FF	pqrs : Column(x size) mnxy: Line (y size) only support: 1920*1080
	rate	8x 01 04 C2 01 0p 0q 0r 0s 0m 0n 0x 0y FF	pqrsmnxy: bitrate (0~15360)
Substream	resolution	8x 01 04 C3 00 0p 0q 0r 0s 0m 0n 0x 0y FF	pqrs : Column(x size) mnxy: Line (y size) only support: 1280*720 1024*576 640*360
	rate	8x 01 04 C3 01 0p 0q 0r 0s 0m 0n 0x 0y FF	pqrsmnxy: bitrate (0~15360)
Tally control	Tally on/off	8x 01 7E 01 0A 00 0p FF	P: 2: on(LED GREEN) 3: off(LED RED)
IP address control	IP set	8x 01 04 AB 0p 0q 0r 0s 0m 0n 0x 0y FF	Set ip to :pq.rs.mn.xy
	Mask set	8x 01 04 AC 0p 0q 0r 0s 0m 0n 0x 0y FF	Set mask to :pq.rs.mn.xy
	Gateway set	8x 01 04 AD 0p 0q 0r 0s 0m 0n 0x 0y FF	Set gateway to : pq.rs.mn.xy
Color adjust	Color adjust OFF	8x 01 04 B6 00 FF	Color adjust off
	Color adjust ON	8x 01 04 B6 01 FF	Color adjust on
	brightness balance OFF	8x 01 04 B7 00 FF	Keep Brightness
	brightness balance ON	8x 01 04 B7 01 FF	No keep Brightness
	Flare red	8x 01 04 B8 dat FF	Flare mode red value

Command type	function	Command packet	Note
			Default is 32
	Flare green	8x 01 04 B9 dat FF	Flare mode green value Default is 32
	Flare green	8x 01 04 BA dat FF	Flare mode blue value Default is 32
SYS_Menu	Menu On	8x 01 06 06 02 FF	Turn on the menu
	Menu Off	8x 01 06 06 03 FF	Turn off the menu
	Menu Back	8x 01 06 06 10 FF	Menu step back
	Menu Ok	8x 01 7E 01 02 00 01 FF	Menu ok
IR_Receive	On	8x 01 06 08 02 FF	IR(remote commander)receive ON/OFF
	Off	8x 01 06 08 03 FF	
	On/Off	8x 01 06 08 10 FF	
Pan_tiltDrive	Up	8x 01 06 01 VV WW 03 01 FF	VV: Pan speed 0x01 (low speed) to 0x18 (high speed) WW: Tilt speed 0x01 (low speed) to 0x14 (high speed) YYYY: Pan Position(TBD) ZZZZ: Tilt Position(TBD)
	Down	8x 01 06 01 VV WW 03 02 FF	
	Left	8x 01 06 01 VV WW 01 03 FF	
	Right	8x 01 06 01 VV WW 02 03 FF	
	Upleft	8x 01 06 01 VV WW 01 01 FF	
	Upright	8x 01 06 01 VV WW 02 01 FF	
	DownLeft	8x 01 06 01 VV WW 01 02 FF	
	DownRight	8x 01 06 01 VV WW 02 02 FF	
	Stop	8x 01 06 01 VV WW 03 03 FF	
	AbsolutePosition	8x 01 06 02 VV WW 0Y 0Y 0Y 0Y 0Z 0Z 0Z 0Z FF	
	RelativePosition	8x 01 06 03 VV WW 0Y 0Y 0Y 0Y 0Z 0Z 0Z 0Z FF	
	Home	8x 01 06 04 FF	
Reset	8x 01 06 05 FF		
Pan-tiltLimitSet	Set	8x 01 06 07 00 0W 0Y 0Y 0Y 0Y 0Z 0Z 0Z 0Z FF	W:1 UpRight 0:DownLeft YYYY: Pan Limit Position(TBD) ZZZZ: Tilt Limit Position(TBD)
	Clear	8x 01 06 07 01 0W 07 0F 0F 0F 0F 0F 0F 0F FF	

## Part 2 Camera Control Command

Command type	command	return	note
CAM_PowerInq	8x 09 04 00 FF	y0 50 02 FF	On
		y0 50 03 FF	Off(Standby)
CAM_ZoomPosInq	8x 09 04 47 FF	y0 50 0p 0q 0r 0s FF	pqrs: Zoom Position
CAM_FocusModelInq	8x 09 04 38 FF	y0 50 02 FF	Auto Focus
		y0 50 03 FF	Manual Focus
CAM_FocusPosInq	8x 09 04 48 FF	y0 50 0p 0q 0r 0s FF	pqrs: Focus Position
CAM_WBModelInq	8x 09 04 35 FF	y0 50 00 FF	Auto
		y0 50 01 FF	Indoor mode
		y0 50 02 FF	Outdoor mode
		y0 50 03 FF	OnePush mode
		y0 50 04 FF	ATW
y0 50 05 FF	Manual		
CAM_RGainInq	8x 09 04 43 FF	y0 50 00 00 0p 0q FF	pq: R Gain
CAM_BGainInq	8x 09 04 44 FF	y0 50 00 00 0p 0q FF	pq: B Gain
CAM_AEModelInq	8x 09 04 39 FF	y0 50 00 FF	Full Auto
		y0 50 03 FF	Manual
		y0 50 0A FF	Shutter priority
		y0 50 0B FF	Iris priority
		y0 50 0D FF	Bright
CAM_ShutterPosInq	8x 09 04 4A FF	y0 50 00 00 0p 0q FF	pq: Shutter Position
CAM_IrisPosInq	8x 09 04 4B FF	y0 50 00 00 0p 0q FF	pq: Iris Position
CAM_GainPosInq	8x 09 04 4C FF	y0 50 00 00 0p 0q FF	pq: Gain Position
CAM_BrightPosInq	8x 09 04 4D FF	y0 50 00 00 0p 0q FF	pq: Bright Position
CAM_ExpCompModelInq	8x 09 04 3E FF	y0 50 02 FF	On
		y0 50 03 FF	Off
CAM_ExpCompPosInq	8x 09 04 4E FF	y0 50 00 00 0p 0q FF	pq: ExpComp Position
CAM_ApertureInq	8x 09 04 42 FF	y0 50 00 00 0p 0q FF	pq: Aperture Gain
CAM_MemoryInq	8x 09 04 3F FF	y0 50 pp FF	pp: Memory number last operated.
SYS_MenuModelInq	8x 09 06 06 FF	y0 50 02 FF	On
		y0 50 03 FF	Off
CAM_LR_ReverseInq	8x 09 04 61 FF	y0 50 02 FF	On
		y0 50 03 FF	Off
CAM_PictureFlipInq	8x 09 04 66 FF	y0 50 02 FF	On
		y0 50 03 FF	Off
CAM_IDInq	8x 09 04 22 FF	y0 50 0p 0q 0r 0s FF	pqrs: Camera ID

CAM_DHCPInq	8x 09 04 AE FF	y0 50 pp FF	
CAM_IPInq	8x 09 04 AB FF	y0 50 0p 0p 0q 0q 0r 0r 0s 0s FF	
CAM_MASKInq	8x 09 04 AC FF	y0 50 0p 0p 0q 0q 0r 0r 0s 0s FF	
CAM_GATEWAYInq	8x 09 04 AD FF	y0 50 0p 0p 0q 0q 0r 0r 0s 0s FF	
CAM_FlareModelInq	8x 09 04 B6 FF	y0 50 pp FF	
CAM_FlareBrightModelInq	8x 09 04 B7 FF	y0 50 pp FF	
CAM_FlareRed	8x 09 04 B8 FF	y0 50 pp FF	
CAM_FlareGreen	8x 09 04 B9 FF	y0 50 pp FF	
CAM_FlareBlue	8x 09 04 BA FF	y0 50 pp FF	
CAM_IDInq			
CAM_VersionInq	8x 09 00 02 FF	y0 50 ab cd mn pq rs tu vw FF	
VideoSystemInq(Telycam)	8x 09 06 23 FF	y0 50 pp FF	pp: Video format
VideoSystemInq(Sony)	8x 09 04 24 72 FF	y0 50 0p 0p FF	pp: Video format
IR_Transfer	8x 09 06 1A FF	y0 50 02 FF y0 50 03 FF	On Off
IR_Receive	8x 09 06 08 FF	y0 50 02 FF y0 50 03 FF	On Off
IR_ReceiveReturn		y0 07 7D 01 04 00 FF	Power ON/OFF
		y0 07 7D 01 04 07 FF	Zoom tele/wide
		y0 07 7D 01 04 38 FF	AF On/Off
		y0 07 7D 01 04 33 FF	CAM_Backlight
		y0 07 7D 01 04 3F FF	CAM_Memory
		y0 07 7D 01 06 01 FF	Pan_tiltDrive
Pan-tiltMaxSpeedInq	8x 09 06 11 FF	y0 50 ww zz FF	ww: PanMaxSpeed zz: Tilt Max Speed
Pan-tiltPosInq	8x 09 06 12 FF	y0 50 0w 0w 0w 0w 0z 0z 0z 0z FF	www: PanPosition zzzz: Tilt Position
MainstreamResolutionInq	8x 09 04 C2 00 FF	y0 50 0p 0q 0r 0s 0m 0n 0x 0y FF	pqrs : Column(x size) mnxy: Line (y size) only support:1920*1080,3840*2160
MainstreamRateInq	8x 09 04 C2 01 FF	y0 50 0p 0q 0r 0s 0m 0n 0x 0y FF	pqrsmnxy: bitrate (0~15360)



SubstreamResolutionInq	8x 09 04 C3 00 FF	y0 50 0p 0q 0r 0s 0m 0n 0x 0y FF	pqrs : Column(x size) mny: Line (y size) only support:1280*720, 1024*576, 640*360
SubstreamRateInq	8x 09 04 C3 01 FF	y0 50 0p 0q 0r 0s 0m 0n 0x 0y FF	pqrsmnxy: bitrate (0~15360)

Note: [x] means the camera address ; [y] = [x]+[8] .

#### VISCA PAN TILT ABSOLUTE POSITION VALUE

Pan Angle	VISCA Value	Tilt Angle	VISCA Value
-170	0xF670	-30	0xFE50
-135	0xF868	0	0x0000
-90	0xFAF0	30	0x01B0
-45	0xFD78	60	0x0360
0	0x0000	90	0x510
45	0x0288		
90	0x0510		
135	0x0798		
170	0x0990		

#### VISCA PAN TILT SPEED VALUE

Pan(Degree/Second)		Pan(Degree/Second)	
0	0.3	0	0.3
1	1	1	1
2	1.5	2	1.5
3	2.2	3	2.2
4	2.4	4	3.6
5	2.6	5	4.7
6	2.8	6	6
7	3.0	7	8
8	3.2	8	10
9	3.4	9	12
10	3.8	10	15
11	4.5	11	18
12	6	12	23
13	9	13	30
14	15	14	39
15	19	15	48
16	25	16	59
17	32	17	69
18	38	18	80
19	45		
20	58		
21	75		
22	88		
23	105		
24	120		

# PELCO-D PROTOCOL COMMAND LIST

Function	Byte1	Byte2	Byte3	Byte4	Byte5	Byte6	Byte7
Up	0xFF	Address	0x00	0x08	Pan Speed	Tilt Speed	SUM
Down	0xFF	Address	0x00	0x10	Pan Speed	Tilt Speed	SUM
Left	0xFF	Address	0x00	0x04	Pan Speed	Tilt Speed	SUM
Right	0xFF	Address	0x00	0x02	Pan Speed	Tilt Speed	SUM
Upleft	0xFF	Address	0x00	0x0C	Pan Speed	Tilt Speed	SUM
Upright	0xFF	Address	0x00	0x0A	Pan Speed	Tilt Speed	SUM
DownLeft	0xFF	Address	0x00	0x14	Pan Speed	Tilt Speed	SUM
DownRight	0xFF	Address	0x00	0x12	Pan Speed	Tilt Speed	SUM
Zoom In	0xFF	Address	0x00	0x20	0x00	0x00	SUM
Zoom Out	0xFF	Address	0x00	0x40	0x00	0x00	SUM
Focus Far	0xFF	Address	0x00	0x80	0x00	0x00	SUM
Focus Near	0xFF	Address	0x01	0x00	0x00	0x00	SUM
Set Preset	0xFF	Address	0x00	0x03	0x00	Preset ID	SUM
Stop	0xFF	Address	0x00	0x00	Pan Speed	Tilt Speed	SUM
Clear Preset	0Xff	Address	0x00	0x05	0x00	Preset ID	SUM
Call Preset	0Xff	Address	0x00	0x07	0x00	Preset ID	SUM
Query Pan Position	0Xff	Address	0x00	0x51	0x00	0x00	SUM
Query Pan Position Response	0Xff	Address	0x00	0x59	Value High Byte	Value Low Byte	SUM
Query Tilt Position	0Xff	Address	0x00	0x53	0x00	0x00	SUM
Query Tilt Position Response	0Xff	Address	0x00	0x5B	Value High Byte	Value Low Byte	SUM
Query Zoom Position	0Xff	Address	0x00	0x55	0x00	0x00	SUM
Query Zoom Position Response	0Xff	Address	0x00	0x5D	Value High Byte	Value Low Byte	SUM

# PELCO-P PROTOCOL COMMAND LIST

Function	Byte1	Byte2	Byte3	Byte4	Byte5	Byte6	Byte7	Byte8
Up	0xA0	Address	0x00	0x08	Pan Speed	Tilt Speed	0xAF	XOR
Down	0xA0	Address	0x00	0x10	Pan Speed	Tilt Speed	0xAF	XOR
Left	0xA0	Address	0x00	0x04	Pan Speed	Tilt Speed	0xAF	XOR
Right	0xA0	Address	0x00	0x02	Pan Speed	Tilt Speed	0xAF	XOR
Upleft	0xA0	Address	0x00	0x0C	Pan Speed	Tilt Speed	0xAF	XOR
Upright	0xA0	Address	0x00	0x0A	Pan Speed	Tilt Speed	0xAF	XOR
DownLeft	0xA0	Address	0x00	0x14	Pan Speed	Tilt Speed	0xAF	XOR
DownRight	0xA0	Address	0x00	0x12	Pan Speed	Tilt Speed	0xAF	XOR
Zoom In	0xA0	Address	0x00	0x20	0x00	0x00	0xAF	XOR
Zoom Out	0xA0	Address	0x00	0x40	0x00	0x00	0xAF	XOR
Focus Far	0xA0	Address	0x00	0x80	0x00	0x00	0xAF	XOR
Focus Near	0xA0	Address	0x01	0x00	0x00	0x00	0xAF	XOR
Stop	0xA0	Address	0x00	0x00	Pan Speed	Tilt Speed	0xAF	XOR
Set Preset	0xA0	Address	0x00	0x03	0x00	Preset ID	0xAF	XOR
Clear Preset	0xA0	Address	0x00	0x05	0x00	Preset ID	0xAF	XOR
Call Preset	0xA0	Address	0x00	0x07	0x00	Preset ID	0xAF	XOR
Query Pan Position	0xA0	Address	0x00	0x51	0x00	0x00	0xAF	XOR
Query Pan Position Response	0xA0	Address	0x00	0x59	Value High Byte	Value Low Byte	0xAF	XOR
Query Tilt Position	0xA0	Address	0x00	0x53	0x00	0x00	0xAF	XOR
Query Tilt Position Response	0xA0	Address	0x00	0x5B	Value High Byte	Value Low Byte	0xAF	XOR
Query Zoom Position	0xA0	Address	0x00	0x55	0x00	0x00	0xAF	XOR
Query Zoom Position Response	0xA0	Address	0x00	0x5D	Value High Byte	Value Low Byte	0xAF	XOR

# OSD MENU

1. Under working mode, press the MENU key on the IR remote controller, to enter the OSD menu as below:



2. After enter the main menu, use the navigate UP/DOWN key to select the main menu. Once been selected, the main menu will change to blue background, and the right side will show all sub menu options.

3. Press the navigate RIGHT key to enter sub menu; use UP/DONW key to select the sub menu; use LEFT/RIGHT key to select parameter.

4. Press the Back key again to return to previous menu. Press the Back key continuously to exit the OSD menu.

## 5. OSD Menu Setting List

SYSTEM	LANGUA GE	Optional Item:Chinese /English	Default English
	PROTOCOL	Optional item VISCA /PELCO -P/PELCO -D	Default VISCA
	ADD RES S	VISCA :1~7 PELCO -P/D:1~255	Default 1
	BAUD RA TE	Optional item: 2400 /4800 /9600 /115200	Default 9600
	RETURN	Return to previous menu	
FOCUS	FOCUS MODE	AUTO/ MANUA L/PUS H	Default AUTO
	FOCUS LIMIT	1.5~10M Reference distance: 15/ 2.3/6/10M	Default 1.5M
	DZO OM	Turn on/o digi <del>z</del> oom (2x digi <del>z</del> om)	Default OFF
	RATIO DIS	ON/O FF	Default OFF
	RETURN	RETURN to previous menu	

EXPOSURE	EXPOSURE MODE	AUTO /MANUAL /BRIGHT /SHUTTER /IRIS	Default AUTO
	SHUTTER	Shutter speed:1/8~1/10000,only valid under manual mode	Default AUTO
	IRIS	Iris setting:0~13, only valid under manual mode	Default AUTO
	GAIN	Gain setting: 0~15,only valid under manual mode	Default AUTO
	BRIGHT	Bright setting:0~20, only valid under bright priority mode.	Default 8
	FLICK	AntiFlicker setting:50/60HZ/OFF, to reduce the video flicker	Default 50HZ
	BACK LIGHT	ON/OFF	Default OFF
	GAMMA	Gamma curve selection	Default 0
	RETURN	Return to previous menu	
IMAGE	WB MODE	Optional AUTO INDOOR OUTDOOR MANUAL OUTAUTO SODIUM LAMP AUTO SODIUM LAMP	Default ATW
	R GAIN	Red gain level: 0~255, only valid under manual white balance mode.	Default AUTO
	B GAIN	Blue gain level:0~255 ,only valid under manual white balance mode	Default AUTO
	DEFOG	OFF, 1~15	Default OFF
	RETURN	Return to previous menu	

QUALITY	2D NR	2D noise reduction: the bigger value, the less noise on image, the lower resolution	Default OFF
	3D NR	3D noise reduction:OFF/AUTO0~4, the bigger value, the less motion noise on image high value will cause image smear.	Default AUTO
	SHARPNESS	Sharpness setting: 0~15, the higher value, edge of the image will be sharpen	Default 3
	CONSTRAS	Set contrast level	Default 8
	SATURATION	Set saturation.	Default 7
	BRIGHT	Whole image bright	Default 8
	D_WDR	Set wide dynamic range: OFF, -6	Default OFF
	RETURN	Return to previous menu	
CONTROL	MIRROR	Default: OFF	
	FLIP	Default OFF	
	D/N MODE	Default Day	
	GAIN LIMIT	Default 128	
	RETURN		
FORMAT	1080P60	Once selected, press OK key to confirm, if it is the selected video format, there is no change.	
	1080P50		
	1080I60		
	1080I50		
	1080P30		
	720P60		
	720P50		
	720P30		
	720P25		
	Return		

RESET	CAM RESET	Reset camera parameter to default
	PTZ RESET	Reset pan/tilt parameter to default
	ALL RESET	Reset all parameter to default
	RETURN	Return to the previous menu
INFO	CONTROL VER	Camera control firmware version
	CONTROL DATE	Camera control firmware releasing date
	FORMAT	Current video output formate
	BAUD RATE	Current RS232 baud rate
	IP ADDR	Camera IP address
	NET MASK	Current subnet mask
	RETURN	Return to the previous menu

#### Set IP Address in Menu

1. Press **menu** button for 3 seconds, enter IP setting menu.

```

-----IP SET-----
IP: 192.168.002.188
MASK:255.255.255.000
GW: 192.168.002.001
MENU/E&S HOME/ENTER

```

2. Using **up** **down** navigation key to select parameter needed to set. IP, Mask, Gateway ect can be set.
- 3.Short press **Home** key to setting mode, current setting parameter starts flickering
4. Short press number key to set needed parmater. After finishing setting, press **Home** key again.
5. If need to exit to menu, press **menu** key. Note: Only press **Home** key after finishing setting can save current paramter.

# UVC CONTROL

1. Only run the client software after the USB3.0 camera has completed self-configuration (the IR indicator in blue color and will not flash); otherwise may cause black video issue.
2. Make sure the USB3.0 camera is recognized by the PC Device Manager.
3. Make sure the interval of video format switching more than 3 seconds, otherwise black video maybe caused.
4. Make sure the interval of control command sending from the server (via USB) to the camera no less than 250ms.
5. Support standard UVC interface.

PU_BRIGHTNESS_CONTROL	81 01 04 4d 00 00 0p 0q FF
PU_CONTRAST_CONTROL	81 01 04 A2 00 00 0p 0q FF
PU_SATURATION_CONTROL	81 01 04 A1 00 00 0p 0q FF
PU_SHARPNESS_CONTROL	8x 01 04 42 00 00 0p 0q FF
PU_GAMMA_CONTROL	8x 01 04 5B 0p FF
PU_WHITE_BALANCE_TEMPERATURE_CONTROL	8x 01 04 35 0X FF
PU_BACKLIGHT_COMPENSATION_CONTROL	81 01 04 33 02/03 FF
PU_POWER_LINE_FREQUENCY_CONTROL	8x 01 04 AA 00/01/02 FF
CT_ZOOM_ABSOLUTE_CONTROL	8x 01 04 47 0p 0q 0r 0s FF
CT_PANTILT_ABSOLUTE_CONTROL	8x 01 06 02 VV WW 0Y 0Y 0Y 0Z 0Z 0Z 0Z F
CT_PANTILT_RELATIVE_CONTROL	8x 01 06 01 pp qq rr ss FF
CT_ZOOM_RELATIVE_CONTROL	8x 01 04 07 pp FF



# WEB SETTING

## 1. Download Active-X to install

When visit IP camera via Internet Explore browser the first time, the system will install camera Active-X automatically.

### How to install

Input IP camera address in IE, the default address is 192.168.1.188, to enter into login page, the system will indicate to install Active-X as following, and then press “Allow installing”



If the following interface showing, to press “install” to complete.

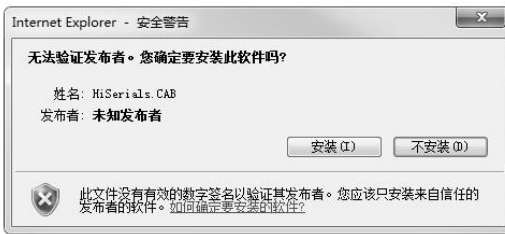

If the following interface showing when installs the Active-X, please go to IE too—>Internet options—>Security—>Custom Level and revise the IE security level manually as following instruction:



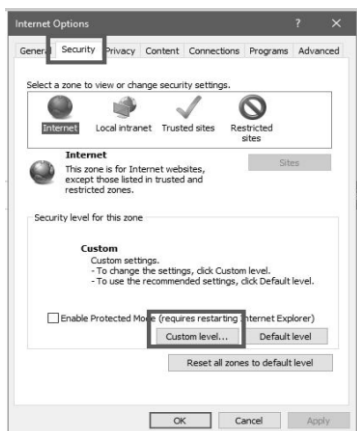

## 2. Login

Once install Active-X, reopen IE browser, and enter into IP address, to login interface, input admin and password to login as following:

Default admin: admin    Default password: admin

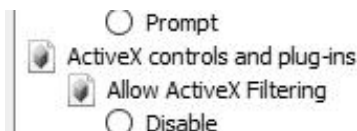

## 3. Real-time Preview:



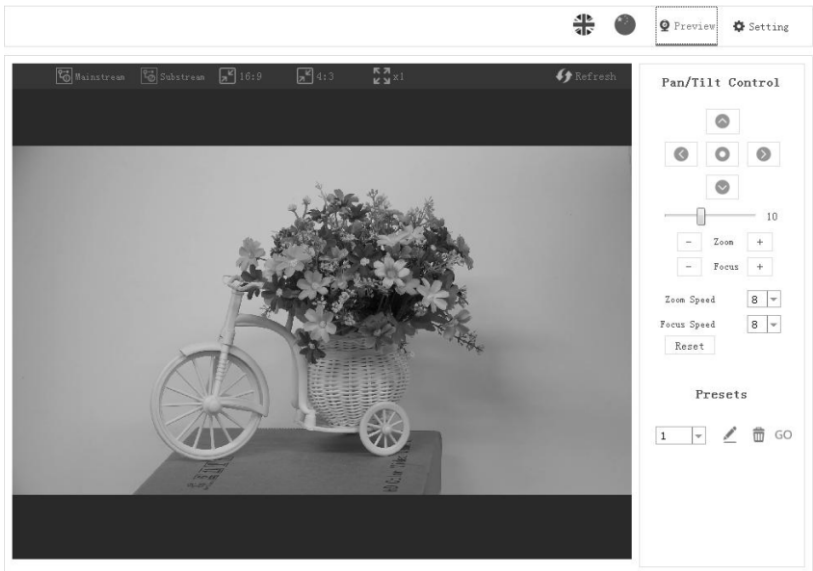

Preview interface as above image, on the right side, there are options to control camera pan, tilt, zoom, focus, presets, focus speed, zoom speed can be set. On the top of the image, main stream and sub stream preview can be selected, image width&height rate can be selected, and full size view can be selected. Besides, English and Chinese language is optional.

#### 4. Parameter Setting

Click "Setting" to enter into parameter setting interface as following:

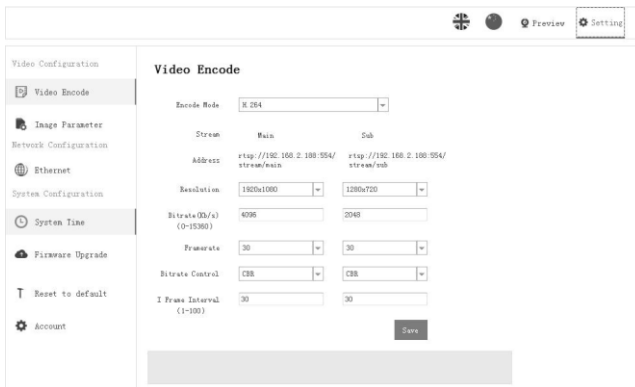

“Video Encode ”: can set image encode mode, main stream and sub stream resolution/bit rate/frame rate, bit rate control way, and I frame interval etc as above image

“Image Parameter ”can set focus, exposure, white balance, image, image quality, noise-reduction, as following picture

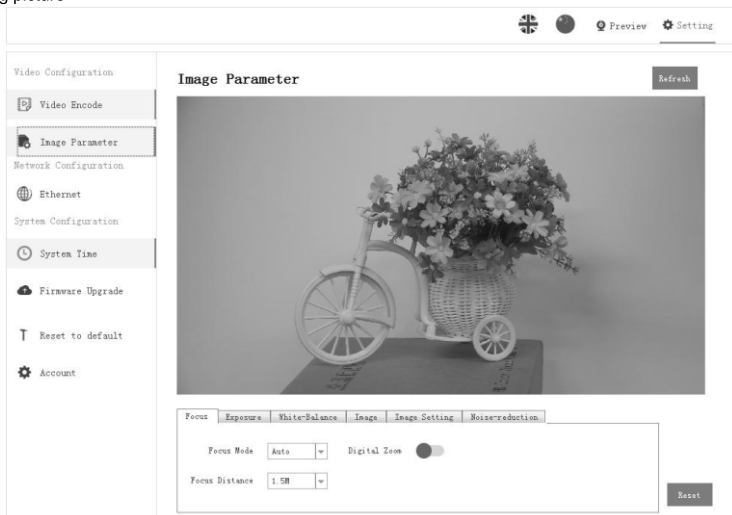

Focus including focus mode, default focal distance, digital zoom etc

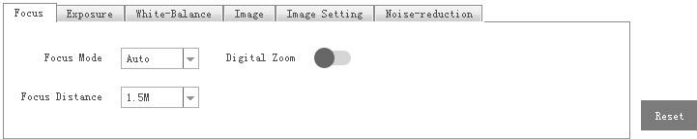

Exposure includes exposure mode, shutter speed, gain, iris, brightness, and anti-flicker.



White Balance includes white balance mode, red gain, blue gain.

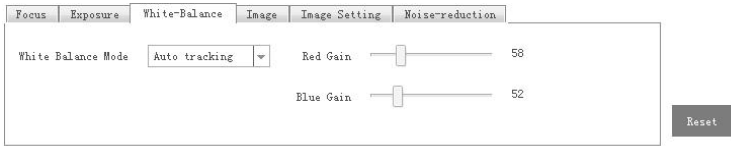

Image includes mirror, flip, backlight compensation, Gamma, WDR(wide dynamic range). WDR parameter can be set when it is ON.

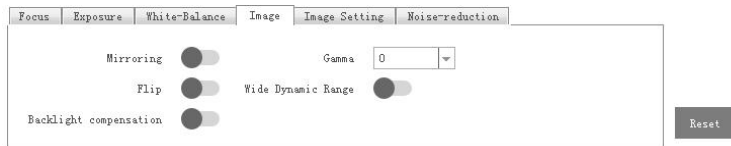
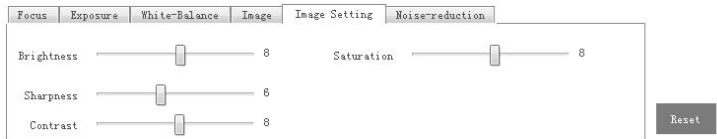
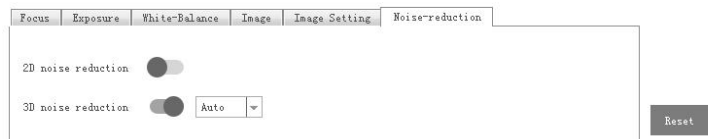

Image Setting includes brightness, sharpness, contrast, saturation



Noise reduction includes 2D/3D reduction. There is on/off option for 2D, and off/auto/1~4 six options.



“Ethernet” includes DHCP mode, IP address, subnet mask, default gateway, http port, web port, main stream port, sub stream port.

Default parameter as following:

DHCP	OFF	HTTP port	80
IP address	192.168.1.188	Web port	6087
Subnet mask	255.255.255.0	Main stream port	554
Default gateway	192.168.1.1	Sub stream port	554

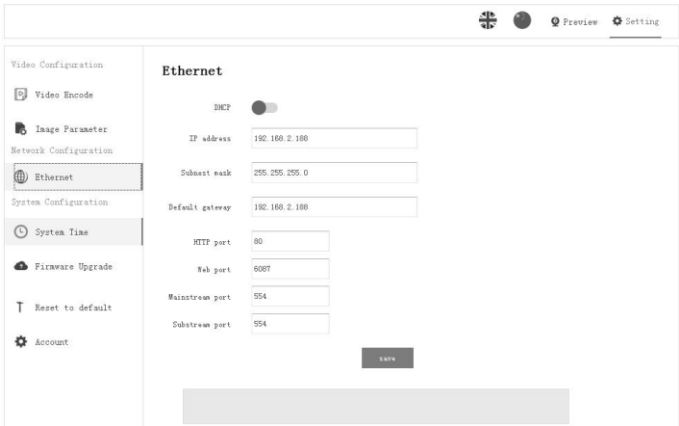

“Firmware” upgrade : it is for camera program upgrade, currently only for ISP part update. How to update:

As following picture, click “clicking to upload file” icon, open dialog box, select to open the file, and click “upgrade” to start.

DO NOT power off or do other operation when upgrading, reboot the camera after 5 min when upgrade finished.

Then login web end to select reset all to reset the camera completely.

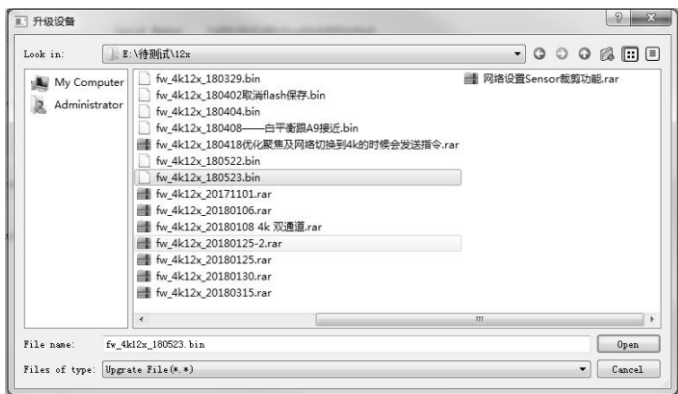
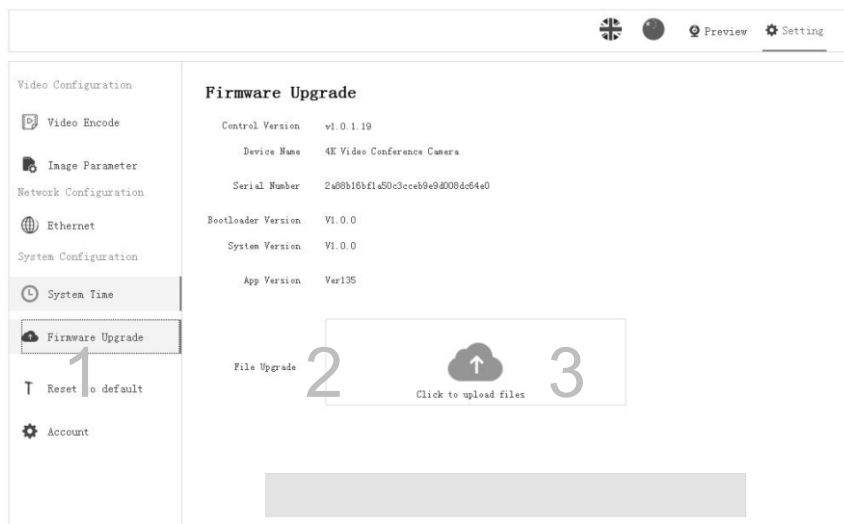

Reset to default is to reset the camera in default setting

Reset simply: reset camera image parameter

Reset all: reset camera Ethernet and image parameter, language and protocol will not be reset.

Reboot: Reboot ISP part of camera

The screenshot shows the 'Reset to default' page in the web interface. The left sidebar contains a navigation menu with categories: Video Configuration (Video Encode, Image Parameter), Network Configuration (Ethernet), System Configuration (System Time, Firmware Upgrade, Reset to default, Account). The main content area is titled 'Reset to default' and contains three sections:

- Reset simply:** A button labeled 'Reset simply' followed by a text input field with the placeholder text 'To reset the image parameter'.
- Reset completely:** A button labeled 'Reset completely' followed by a text input field with the placeholder text 'To reset all parameter and reboot the device'.
- Reboot:** A button labeled 'Reboot'.

Account is used for setting camera account and password

Input the account firstly, then input same password twice, click set to finish

Please remember account and password, otherwise you may be not able to login.

The screenshot shows the 'Account Setting' page in the web interface. The left sidebar is identical to the previous screenshot, with 'Account' selected. The main content area is titled 'Account Setting' and contains three text input fields:

- Account
- Password
- Confirm Password

Below the input fields is a 'Set' button. A large grey rectangular area is present at the bottom of the main content area.



# VISCA OVER IP

VISCA over IP means VISCA protocol transmit via IP, to reduce RS232/RS485 cable layout (the controller must support IP communication function)

Communication port spec:

- Control port: RJ45 Gigabit LAN
- IP protocol: IPv4
- Transmit protocol: UDP
- IP address: set via web end or OSDmenu
- Port address: 52381
- Confirm send/transmission control: depend on applied program
- Applied range: in the same segment, not suitable for bridge network.
- Turn on camera: In the menu, set VISCA option to OVER IP

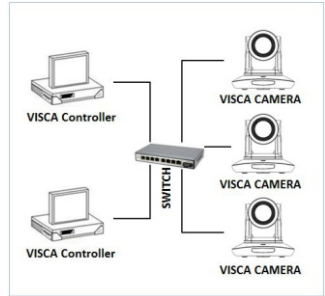

How to use VISCA over IP

VISCA Command

It means commands from controller to peripheral equipment, when peripheral equipment receives commands, then return ACK. When commands executed, will return complete message. For different commands, camera will return different message.

VISCA Inquiry

It means inquiry from controller to peripheral equipment when peripheral equipment receives this kind of commands, it will return required message.

VISCA Reply

It means ACK, complete message, reply or error reply, it is sent from peripheral equipment to controller.

Command format: the following is message head and valid message format.

## USING VCL TO VIEW RTSP VIDEO

Default RTSP main streaming address: `rtsp://192.168.1.188/stream/main`

Default RTSP sub streaming address: `rtsp://192.168.1.188/stream/sub`

- 1, Open VLC media player
- 2, Media->network stream, to enter into "open media" interface.
- 3, Input RTSP address in URL as following:



- 4, Click play to view the real time image.

Note: If there is much image lag, select "more option" to enter into following setting, change buffer time smaller (VLC default buffer time is 1000ms).



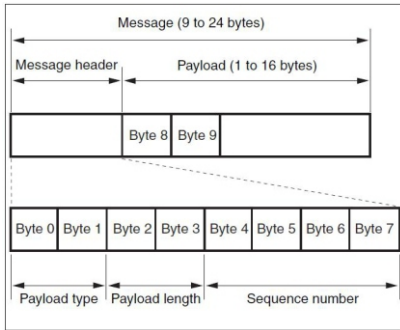

Note: LAN output way is big-endian, LSB is in the front.

Payload type:

Data definition as following:

Name	Value (Byte 0)	Value (Byte 0)	Value (Byte 0)
VISCA command	0x01	0x00	Stores the VISCA command.
VISCA inquiry	0x01	0x10	Stores the VISCA inquiry.
VISCA reply	0x01	0x11	Stores the reply for the VISCA command and VISCA inquiry, or VISCA device setting command.
VISCA device setting command	0x01	0x20	Stores the VISCA device setting command.
Control command	0x02	0x00	Stores the control command.
Control reply	0x02	0x01	Stores the reply for the control command.

Payload length

Valid data length in Payload (1~16), is command length.

For example, when valid data length is 16 byte

Byte 2 : 0x00

Byte 3 : 0x10

Controller will save sequence number of each command, when one command sent, the sequence number of the command will add 1, when the sequence number becomes the max value, it will change to 0 for next time.

The peripheral equipment will save sequence number of each command, and return the sequence number to the controller.

#### Payload

According to Payload type, the following data will be saved.

- VISCA command  
Save VISCA command packet
- VISCA inquiry  
Save VISCA message packet
- VISCA reply  
Save VISCA return packet
- VISCA device setting command  
Save VISCA equipment setting command packet.
- Control command

The following data is saved in control command payload

Name	Value	Description
RESET	0x01	Resets the sequence number to 0. The value that was set as the sequence number is ignored.
ERROR	0x0Fyy	yy=01: Abnormality in the sequence number.
		yy=02: Abnormality in the message (message type)

- Controlled reply

The following data is saved in return command payload of control command.

Message	Value	Description
ACK	0x01	Reply for RESET.

#### Delivery confirmation

VISCA over IP uses UDP as transmission communication protocol, UDP communication message transmission is not stable, it is necessary to confirm delivery and resent in application. Generally, when controller sends a command to peripheral equipment, controller will wait for the return message then send the

next command, we can detect and confirm if the peripheral equipment receive the commands from return message's lag time. If controller shows it is overtime, it is regarded as error transmission.

If controller shows it is overtime, resend the commands to check peripheral's status, resend command sequence number is same as last command, the following chart list the received message and status after resending the commands.

Lost message	Received message for retransmission	Status after retransmission	Correspondence after retransmission
Command	ACK message	Command is performed by retransmission.	Continue processing.
ACK message	ERROR (Abnormality in the sequence number.)	Command has been performed. If only the ACK message is lost, the completion message returns.	If the result by the completion message is needed, retransmit by updating the sequence number.
Completion message for the command	ERROR (Abnormality in the sequence number.)	Command has been performed.	If the result by the completion message is needed, retransmit by updating the sequence number.
Inquiry	Reply message	Inquiry is performed by retransmission.	Continue processing.
Reply message for the inquiry	ERROR (Abnormality in the sequence number.)	Inquiry has been performed.	If the result by the reply message is needed, retransmit by updating the sequence number.
Error message	Error message	Command is not performed. If the error cause eliminates, normal reply is returns (ACK, reply message).	Eliminate the error cause. If normal reply returns, continue processing.
Inquiry of the VISCA device setting command	Reply message of the VISCA device setting command	Inquiry has been performed by retransmission.	Continue processing.
Reply message of the VISCA device setting command	ERROR (Abnormality in the sequence number.)	Inquiry has been performed.	If the result by the reply message is needed, retransmit by updating the sequence number.

Sequence chart as following

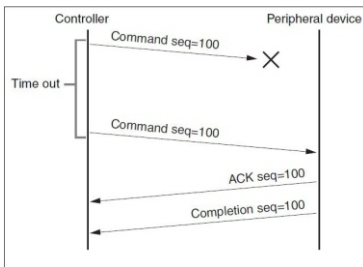

Sequence chart when command

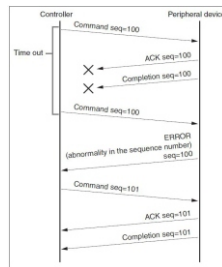

Sequence chart when returned message lost

Note: Do not set IP address, subnet mask, gateway parameter in VISCA over IP command, otherwise, it will cause network breaks off. Due to change these parameter, network will be in off status.

Copyright© Angekis Technology Co.,Ltd All Rights Reserved.



---

WEB

FACEBOOK

<https://www.angekis.com>