

## Description

Front View

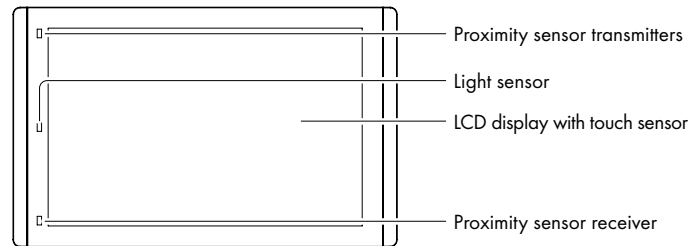

Rear View

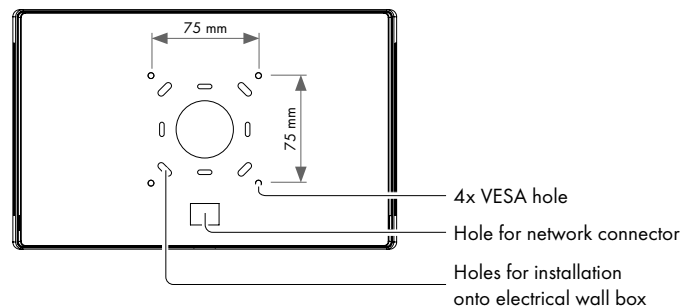

Side View

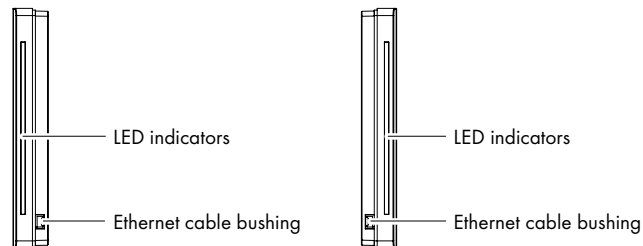

Bottom View

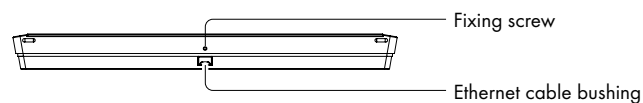

## Connection

### Ethernet without PoE Infrastructure

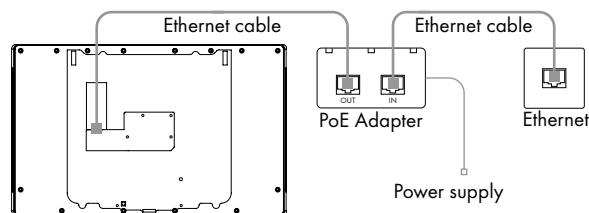

### Ethernet with PoE Infrastructure

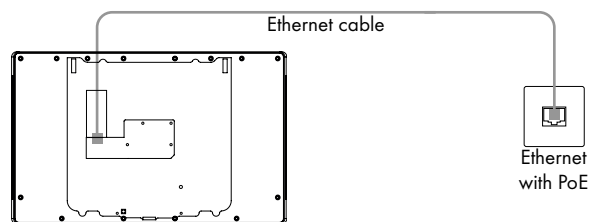

## User Manual And Installation Guides

Complete user manual and installation guides can be downloaded from <http://www.touchone.eu>

## Box Contents

- Touch panel touchONE-10-M incl. back cover
- Fixing screws & Allen key
- Cleaning tissue
- Adhesive cover foil
- Adhesive tapes
- Squeegee
- Set of cable bushings
- Quick Start
- Declaration of Conformity & Warranty Conditions

## Factory Default Setup

When the Reset button is pressed longer than 5 sec., the factory default function is performed and setup is as follows:

- IP address: from DHCP
- IP Mask: from DHCP
- Password: Empty (no input required)
- All settings and logo are deleted

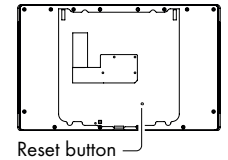

## Installation

1. Loosen the fixing screw using delivered Allen key.
2. Remove front panel from back cover.
3. Install the cable so that it passes through the back cover hole. Fix back cover on the wall using appropriate screws depending on the wall material.  
Recommended cable length from the wall is 25 cm. Recommended height from the floor to the center of the panel is 150 cm.
4. Connect Ethernet cable to the panel and put the panel on the back cover.
5. Carefully tighten the fixing screw to fix panel on the back cover.

# Multisurface models installation - using adhesive foil

**cue**

## Step 1

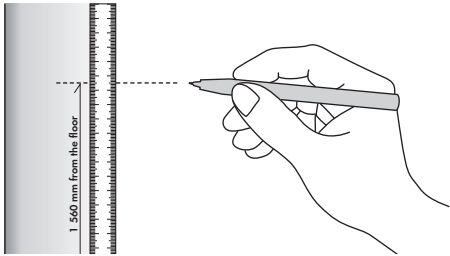

Degrease (typically glass) surface with alcohol and let it dry. Sign top of foil in height 1 560 mm from the floor. It is for recommended height 1 500 mm from floor to center of the panel.

## Step 2

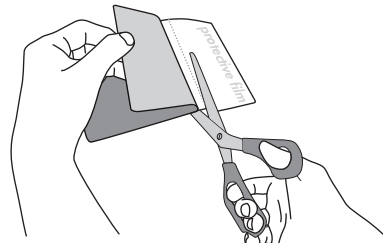

Partly remove protective film from adhesive foil and cut it.

## Step 3

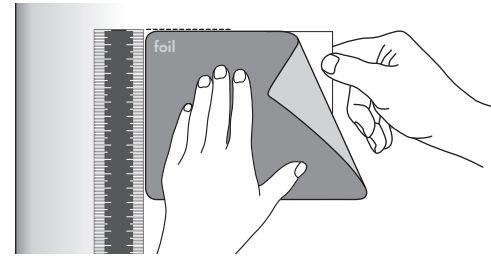

Use vertical ruler or level to adjust correct foil vertical position. Put foil on the wall with the protective film (not with adhesive part) to the ruler or level.

## Step 4

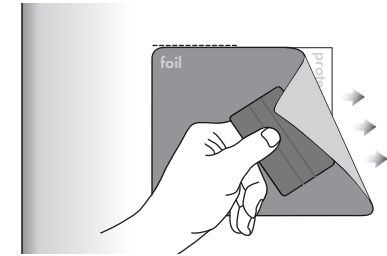

Stick the adhesive part of foil using delivered squeegee.

## Step 5

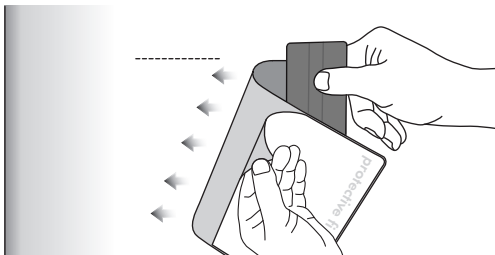

Partially remove the protective film and stick the rest of the foil using a squeegee.

## Step 6

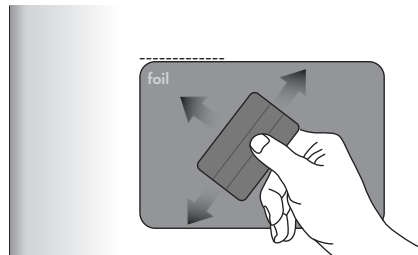

Squeegee lengthwise from the center outwards with overlapping strokes.

## Step 7

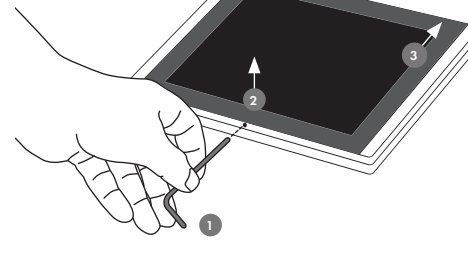

Loosen the fixing screw using delivered Allen key - ① and remove back cover of the panel - ②, ③.

## Step 8

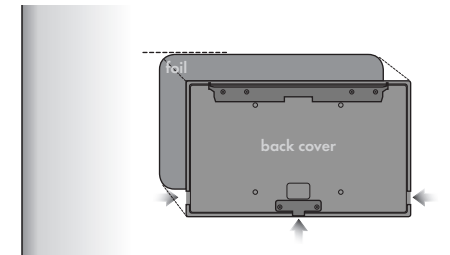

Position of back cover must be oriented as displayed above - cable bushings are left, right and below side oriented.

## Step 9

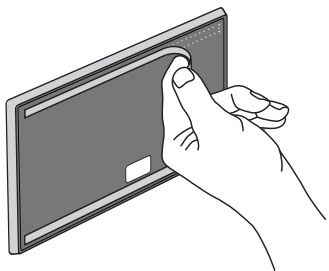

Degrease the back of the panel and attach two double-sided adhesive strips to the back of the panel. The strips should be located along the top and bottom edge of the back panel.

## Step 10

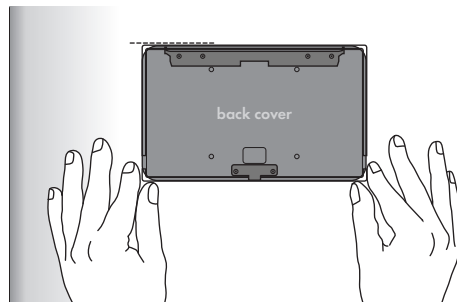

Degrease foil installed on the wall and left it completely dry. Remove protective film from the adhesive tape (installed on the rear side of the back cover) and carefully attach it on the foil installed on the wall.

## Step 11

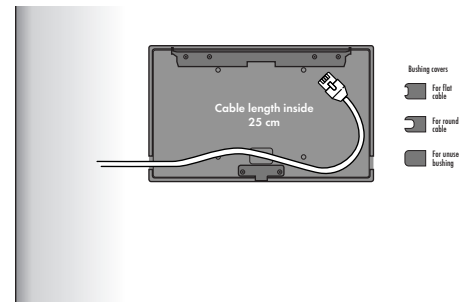

Install cable to the selected bushing and install appropriate cable cover. Cable length inside is 25 cm. Covers for flat and round cables as well as for unused bushings are delivered. Covers are fixed with adhesive tape.

## Step 12

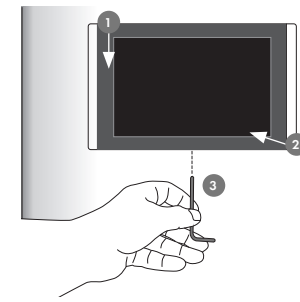

Connect Ethernet cable to the panel and put the panel on the back cover - ①, ②. Carefully tighten the fixing screw to fix panel on the back cover - ③.