

PLIXUS

USER & INSTALLATION GUIDE

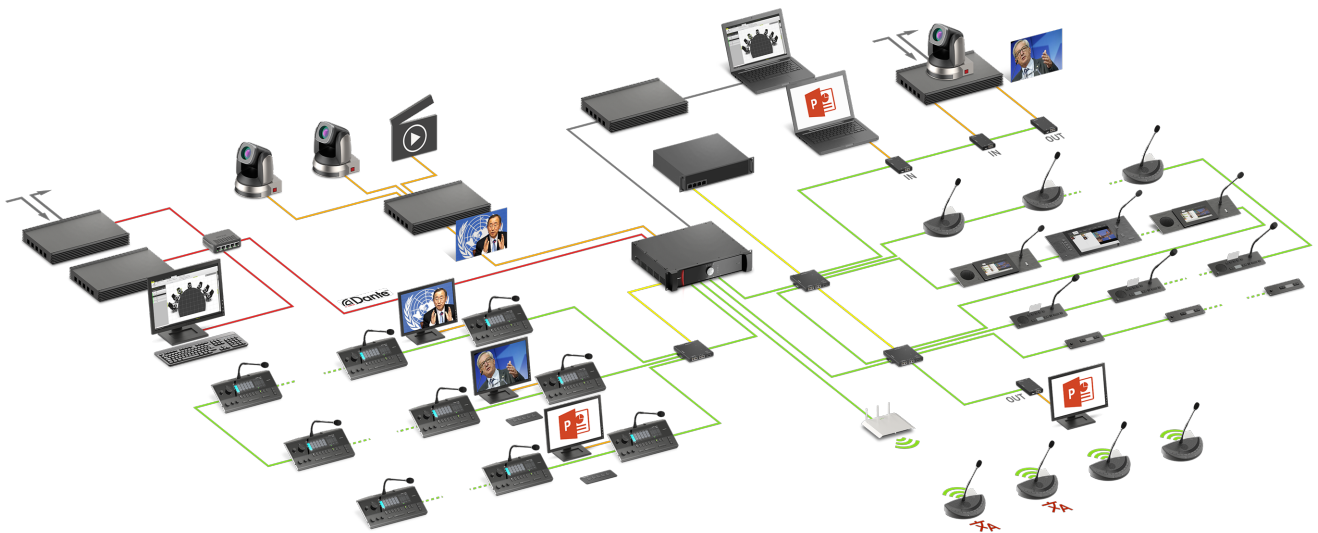

Copyright Statement

No part of this publication or documentation accompanying this product may be reproduced in any form or by any means or used to make any derivative such as translation, transformation, or adaptation without the prior written permission of the publisher, except in case of brief quotations embodied in critical articles or reviews. Contents are subject to change without prior notice.

Copyright © 2018 by Televic Conference NV. All rights reserved.

The authors of this manual have made every effort in the preparation of this book to ensure the accuracy of the information. However, the information in this manual is supplied without warranty, either express or implied. Neither the authors, Televic Conference NV, nor its dealers or distributors will be held liable for any damages caused or alleged to be caused either directly or indirectly by this book.

Trademarks

All terms mentioned in this manual that are known to be trademarks or service marks have been appropriately capitalized. Televic NV cannot attest to the accuracy of this information. Use of a term in this book should not be regarded as affecting the validity of any trademark or service mark.

CONTENTS

Introduction

Getting started	8
About this manual	8
Compatibility	9
About Plixus	10
Concept and design	10

Safety instructions

Safety instructions	12
Safety	12
FCC & ICES Information	12
Conformity and Certification Info for Japan	13
Important safety instructions	14
Power connections	16

Plixus components

Components	19
General overview	19
Component range	21
Plixus MME	22
Overview	22
Control dial functionality	22
Rear connectivity	24
Dante™ interface	25
Supported Video Formats	26
Factory defaults restore button	26
Plixus AE-R	27
Overview	27
Recording feature	27
Rear end connectivity	28
Power supply	28
Factory defaults restore button	28
Plixus Power Supply	30
Plixus AE-R power supply	30
Plixus power supply	30

Plixus NEXT	31
DIP switch table	32
General Network Extender Guidelines	32
Redundancy	33
Video-IN	35
Video-In box	35
Video request	36
Video-OUT	37
Video-Out box	37
Video selection	38
Video stream routing	39
Delegate equipment	40
Audio only equipment	40
Multimedia equipment	40
Advanced delegate equipment	40
Interpreter equipment	41

Installation design

Plixus component properties	43
100 Mbit powered over Plixus Cable	43
1 Gbit powered over Plixus cable	43
1 Gbit externally powered	44
General installation guidelines	46
Units per branch / loop	46
When to use a network extender	46
Installation diagram	48
Configuration with Plixus engine only	48
Configuration with network extender	48
Examples	52
Power supply design	53
Power availability and consumption table	53
Plixus AE-R power supply	53
Calculator tool	54
Cable requirements	54
Combine Plixus with Confidea G3	56
Combine wired and wireless units	56
Combine interpretation with wireless units	57
Range extension with multiple access points	58
Split and combine rooms	59
Create redundancy	59

Installation process

Introduction	62
Power supply	63
Power uniCOS units, network extenders and uniBOX	63
Power supply of the central unit	63
Install cables	65
Install microphones	66
General microphone characteristics	66
Technical microphone characteristics	66
Microphone connector characteristics	67
Microphone Operation Modes	67
Install delegate units	69
Connect Plixus units	69
Connect to Plixus engine	69
Install Confidea G3	70
Connect Wireless Conference Access Point (WCAP) to Plixus network	70

Configuration





Introduction	72
Plixus Core	72
Plixus Core versus CoCon	72
Configure IP settings	75
Change IP settings in Windows	75
Change IP settings in macOS	77
Getting started with Plixus Core	80
Activate Plixus Core	80
Explore Plixus Core	80
The Home page	83
Initialization	84
Introduction	84
How to initialize units	85
Discussion options	87
Number of open microphones	87
Microphone mode	87
Microphone LED	89
Recording	90
Record using the record button	90
Record using Plixus Core	90
Manage recorded files	92
Audio settings	93

General volume	93
Dynamics processing	93
Auto gain reduction	94
Audio routing	95
Audio routing configuration	95
Auxiliary levels	97
Additional options	97
Interpretation	98
Add new language	98
Add Interpretation configuration from CoCon	99
Operator	100
Regional settings	101
Network settings	102
Network information	102
Camera protocol	102
REST API	103
Users	104
Update versions	105
Update Plixus system	105
Update versions	107
System info	108
Couple with Confidea G3	110
Couple WCAP with engine	110
Associate units with WCAP	111
Takeover WCAP	112

GETTING STARTED

About This Manual

Throughout this guide we use icons to designate different types of information:

	This is a note. A note gives additional information, such as the meaning of the color of the microphone LEDs. A note also provides information that may only be applicable to some situations.
	This is a tip. A tip gives you an alternative way to do a particular step or procedure, or lets you know of an option that you may find helpful.
	This indicates that something is very important. Important information is something that you need to do in order to accomplish a certain task.
	This provides safety precaution information, that is, information that you need to be careful about to prevent potential problems when using our systems.

Compatibility

This user manual applies to the following products:

Product	Version
Plixus MME	≥ CRP 5.2
Plixus AE-R	≥ CRP 5.2
Confidea WCAP G3	≥ 3.1
Confidea G3 delegate units	≥ 3.1

ABOUT PLIXUS

Concept And Design

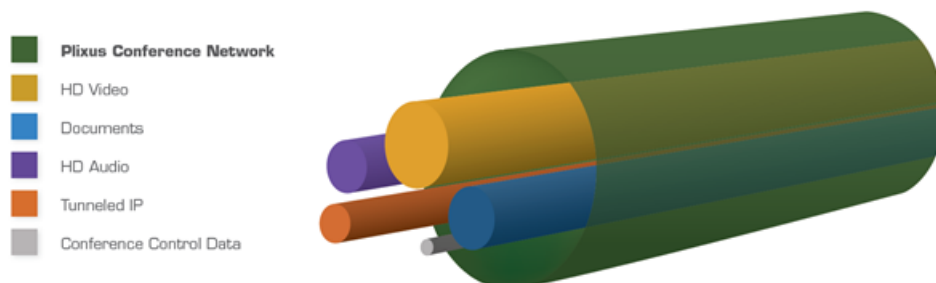

Figure 1-1 : Plixus CAT 5e cable characteristics

Plixus is a state-of-the-art conference architecture that excels in **performance, security & reliability**.

It is a packet-based IP network that radically simplifies the conference architecture by sending all information over a single CAT 5e cable. HQ audio, HD video, and data travel over a single cable. Dedicated bandwidth is reserved for audio and video. The result is permanent and uninterrupted crystal-clear audio and video. Plixus also eliminates the large amount of equipment and cabling that was traditionally required to bring video to each delegate. Video splitters, distribution amplifiers and several cables to each delegate position are no longer needed. As a result, Plixus drastically reduces the installation cost and simplifies the maintainability of the total system architecture.

The Plixus architecture is also engineered with redundancy & maintenance in mind. All delegate stations are interconnected in daisy-chain and the last unit in the chain can close the loop for increased reliability and redundancy. Moreover, Plixus is conceived with a self-healing topology: data will always travel the shortest route and in the case of an error, Plixus will self-correct and reroute data via the fastest available pathway. Ultimately, it offers all parties peace of mind with Plixus' rock-solid reliability.

Finally, Plixus offers the best of both worlds. The mission-critical part of the central unit is entirely closed off while the DANTE™ interface enables third-party devices to communicate with the closed core network. As a result, Plixus acts as a gatekeeper who guarantees safe & secure communication and allows device extensibility via the DANTE™ interface.

SAFETY INSTRUCTIONS

The safety instructions contain general safety guidelines that integrators, installers, operators, end users, and anyone else who installs or uses Televic material is required to read and follow at all times.

Safety

All Televic systems are state of the art devices and have been designed to meet all quality standards. Nevertheless, the individual components of the conference system can cause danger for persons and material assets if

- › the conference system is not used as intended,
- › the conference system is set up by personnel not familiar with the safety regulations,
- › the conference system is converted or altered incorrectly,
- › the safety instructions are not observed.

FCC & ICES Information

(U.S.A and Canadian Models only).

This Class B digital apparatus complies with Canadian norm ICES-003.

Cet appareil numérique de la classe B est conforme à la norme NMB-003 du Canada.

This equipment has been tested and found to comply with the limits for a Class B digital device, pursuant to Part 15 of the FCC Rules. These limits are designed to provide reasonable protection against harmful interference in a residential installation. This equipment generates, uses and can radiate radio frequency energy and, if not installed and used in accordance with the instructions, may cause harmful interference to radio communications. However, there is no guarantee that interference will not occur in a particular installation. If this equipment does cause harmful interference to radio or television reception, which can be determined by turning the equipment off and on, the user is encouraged to try to correct the interference by one or more of the following measures:

- › Reorient or relocate the receiving antenna
- › Increase the separation between the equipment and receiver
- › Connect the equipment into an outlet on a circuit different from that to which the receiver is connected
- › Consult the dealer or an experienced radio/TV technician for help

- Consult the Federal Communications Commission’s manual “How to Identify and Resolve Radio-TV Interference Problems”

Wireless discussion units and the Wireless Access Point comply with Part 15 of the FCC Rules and with RSS-210 of Industry Canada.

Operation is subject to the following two conditions:

1. This device may not cause harmful interference
2. This device must accept any interference received, including interference that may cause undesired operation.



Changes or modifications made to this equipment not expressly approved by Televic Conference NV may void the FCC authorization to operate this equipment.



Wireless discussion units and the Wireless Access Point comply with FCC radiation exposure limits set forth for an uncontrolled environment. These Wireless discussion units and the Wireless Access Point should be installed and operated with minimum distance of 20 cm between the radiator and your body. The RF-parts of the Wireless discussion units and the Wireless Access Point must not be co-located or operating in conjunction with any other antenna or transmitter.

Conformity And Certification Info For Japan

This device has been granted a designation number by Ministry of Internal Affairs and Communications according to:

Ordinance concerning Technical Regulations Conformity Certification etc. of Specified Radio Equipment (特定無線設備の技術基準適合証明等に関する規則)

Article 2 clause 1 item 19/3

Approval No.:

- 202WW10120791/2”
- 202XW10120791/2



This device should not be modified, otherwise the granted designation number will be invalid.

Important Safety Instructions

1. **Read Instructions.** All the safety and operating instructions should be read before the product, device or system is operated.
2. **Retain Instructions.** The safety and operating instructions should be retained for future reference. The instructions should be kept in the vicinity of the product or system.
3. **Heed Warnings.** All warnings on the product and the operating instructions should be closely adhered to.
4. **Follow Instructions.** All instructions for installation or operating/use should be followed closely.
5. **Cleaning.** Unplug this product from the wall outlet before cleaning. Do not use liquid cleaners or aerosol cleaners. Use only a damp cloth for cleaning.
6. **Ventilation.** Any slots and openings in the device or equipment are provided for ventilation and to ensure reliable operation of the product and to protect it from overheating. These openings must not be blocked or covered. The openings should never be blocked by placing the product on a bed, sofa, rug, or other similar surface. This product should not be placed in a built-in installation such as a bookcase or rack unless proper ventilation is provided or the manufacturer's instructions have been adhered to.
7. **Heat.** The product should be situated away from heat sources such as radiators, heat registers, stoves, or other products (including amplifiers) that produce heat. Do not use or operate any equipment in environments that exceed the standard operating temperatures.
8. **Modifications.** Do not use any modifications, extension, or other attachments not recommended by the product manufacturer as they may cause hazards.
9. **Accessories.** Only use attachments/accessories specified by the manufacturer. Do not place this product on an unstable cart, stand, tripod, bracket, or table. The product may fall, causing serious injury to a child or adult, and serious damage to the product. Use only with a cart, stand, tripod, bracket, or table recommended by the manufacturer, or sold with the product. Any mounting of the product should follow the manufacturer's instructions, and should use a mounting accessory recommended by the manufacturer.
10. **Water and Moisture.** Do not use this product near water or in a moistures environment - for example, near a bath tub, wash bowl, kitchen sink, or laundry tub; in a wet basement; or near a swimming pool, in an unprotected outdoor installation; and the like.
11. **Moving.** A product and cart combination should be moved with care. Quick stops, excessive force, and uneven surfaces may cause the product and cart combination to overturn.

12. **Power Sources.** This product should be operated only from the type of power source indicated on the marking label. If you are not sure of the type of power supply to your home, consult your product dealer or local power company. For products intended to operate from battery power, or other sources, refer to the operating instructions.

13. **Power Lines.** An outdoor system should not be located in the vicinity of overhead power lines or other electric light or power circuits, or where it can fall into such power lines or circuits. When installing an outdoor system, extreme care should be taken to keep from touching such power lines or circuits, as contact with them might be fatal. U.S.A. models only - refer to the National Electrical Code Article 820 regarding installation of CATV systems.

14. **Grounding or Polarization.** Do not defeat the safety purpose of the polarized or ground-type plug. A polarized plug has two blades with one wider than the other. A grounding type plug has two blades and a third grounding prong. The wider blade or the third prong are provided for your safety. If the provided plug does not fit into your outlet, consult an electrician for replacement of the obsolete outlet.

15. **Power-Cord Protection.** Power-supply cords should be routed so that they are not likely to be walked on or pinched by items placed upon or against them, paying particular attention to cords at plug, convenience receptacles, and the point where they exit from the product.

16. **Lightning.** For added protection for this product during a lightning storm, or when it is left unattended and unused for long periods of time, unplug it from the wall outlet. This will prevent damage to the product due to lightning and power-line surges. (Not applicable when special functions are to be maintained, such as evacuation systems.)

17. **Overloading.** Do not overload wall outlets, extension cords or integral convenience receptacles as this can result in a risk of fire or electric shock.

18. **Object and Liquid Entry.** Never push objects of any kind into this product through openings as they may touch dangerous voltage points or short-out parts that could result in a fire or electric shock. Never spill liquid of any kind on the product.

19. **Inflammable and Explosive Substance.** Avoid using this product where there are gases, and also where there are inflammable and explosive substances in the immediate vicinity.

20. **Heavy Shock or Vibration.** When carrying this product around, do not subject the product to heavy shock or vibration.

21. **Servicing.** Do not attempt to service this product yourself as opening or removing covers may expose you to dangerous voltage or other hazards. Refer all servicing to qualified service personnel.

22. **Damage Requiring Service.** Unplug this product from the wall outlet and refer servicing to qualified service personnel under the following conditions:

- a. When the power-supply cord or plug is damaged.
- b. if liquid has been spilled, or objects have fallen into the product.
- c. If the product has been exposed to rain or water.
- d. If the product does not operate normally by following the operating instructions. Adjust only those controls that are covered by the operating instructions as an improper adjustment of other controls may result in damage and will often require extensive work by a qualified technician to restore the product to its normal operation.
- e. If the product has been dropped or damaged in any way.
- f. When the product exhibits a distinct change in performance-this indicates a need for service.

23. **Replacement Parts.** When replacement parts are required, be sure the service technician has used replacement parts specified by the manufacturer or have the same characteristics as the original part. Unauthorized substitutions may result in fire, electric shock, or other hazards.

24. **Safety Check.** Upon completion of any service or repairs to this product, ask the service technician to perform safety checks to determine that the product is in proper operating condition.

25. **Coax Grounding.** If an outside cable system is connected to the apparatus, be sure the cable system is grounded. U.S.A. models only: Section 810 of the National Electrical Code, ANSI/NFPA No.70-1981, provides information with respect to proper grounding of the mount and supporting structure, grounding of the coax to a discharge apparatus, size of grounding conductors, location of discharge unit, connection to grounding electrodes, and requirements for the grounding electrode.

26. **Usage:** Non-uniform use of pixels, such as prolonged display of non-moving images (text or graphics), can create a permanent ghost-like image of these objects or otherwise degrade image quality. It can lead to uneven use results in uneven light output over time, and in severe cases can create a ghost image of previous content. While this phenomenon is inherent to LCD technology, Televic recommends a maximum use of 10 consecutive hours of displaying the same content for any product with an LCD or OLED display. After 10 hours of use or at the end of the day it is recommended, if possible, to turn off the displays by shutting down the system. Televic highly discourages any user from leaving a system containing units with an LCD running 24/7.

Power Connections

For permanently connected equipment, a readily accessible disconnect device shall be incorporated in the fixed wiring; For pluggable equipment, the socket-outlet shall be installed near the equipment and shall be easily accessible.

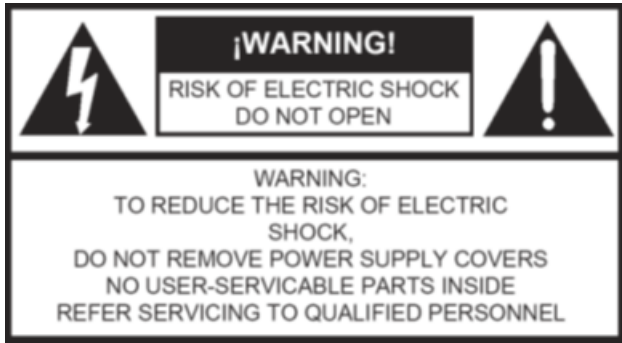

This label may appear on the bottom of the apparatus due to space limitations.



The lightning flash with an arrowhead symbol, with an equilateral triangle, is intended to alert the user to the presence of un-insulated 'dangerous voltage' within the products enclosure that may be of sufficient magnitude to constitute a risk of electric shock to persons.



The exclamation mark within an equilateral triangle is intended to alert the user to the presence of important operating and maintenance (servicing) instructions in the literature accompanying the appliance.



To reduce the risk of fire or electric shock, do not expose this appliance to rain or moisture. Do not open the cabinet; refer servicing to qualified personnel only.



To prevent electric shock, do not use this (polarized) plug with an extension cord receptacle or other outlet unless the blades can be fully inserted to prevent blade exposure.



Installation should be performed by qualified service personnel only in accordance with the National Electrical Code or applicable local codes.



Installation should be performed by qualified service personnel only in accordance with the National Electrical Code or applicable local codes.

COMPONENTS

General Overview

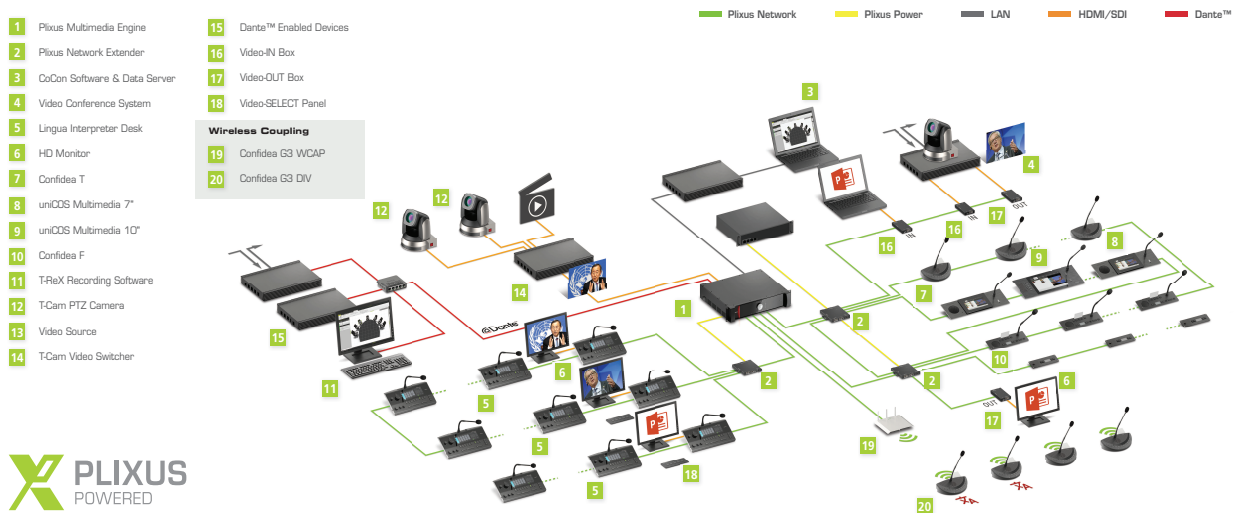

Figure 1-2 Plixus architecture diagram with example setup

The Plixus architecture allows for a mix & match of components: from flushmount devices over multimedia units and interpreter desk to PTZ cameras and third-party Dante™-enabled applications.

A typical setup consists of the following components:

- › A central engine (multimedia or audio-only)
- › CAT 5e network cables
- › Depending on the size of the network: one or more power supplies.
- › Depending on the size of the network: one or more network extenders. Each network extender powers a separate branch. It permits 4 branches or 2 loops.
- › CoCon management software to manage every aspect of the meeting
- › T-Rex recording software to record audio
- › A combination of units
 - › uniCOS units: multimedia flushmount units
 - › Confidea T units: tabletop units (discussion/voting/interpretation)

COMPONENT RANGE

As discussed earlier, you can include different components in your Plixus network. These components can be divided into four different categories:

- › **Central equipment:** the heart of the Plixus network, with these devices you can set up, configure and maintain the Plixus network.
- › **Network equipment**
- › **Multimedia:** these devices support the usage of multimedia during the meeting such as viewing video on delegate units or video injection / extraction from the Plixus network.
- › **Audio:** these units only support receiving and sending audio.
- › **Interpreter equipment:** all equipment needed for interpretation.

PLIXUS MME

Overview



Figure 1-3 Plixus MME front view

The Plixus Multimedia Engine is the heart of the Plixus system. It controls all delegate units and interconnects to other systems either via the external audio connections or control ports (camera control, Dante, central software, API).

The central unit can drive a maximum of 80 Plixus units directly from the engine. In case a large number of units are required, the system can be extended with multiple Plixus Network Extenders.







Control Dial Functionality

The front of the Plixus MME/AE-R has a Jog Wheel with the following options:

- > **Push** the dial to select a Level 1 setting
- > **Turn** the dial to select a Level 2 setting

The following table details the control dial options:

Level		Function
1	2	
	0 to max	Loudspeaker volume

Level		Function
1	2	
	   	Microphone mode: Direct access Microphone mode: Request Microphone mode: VoX Microphone mode: Group
	0 to 8	Maximum number of open microphones
	0 to max	Plixus MME headphone volume

 Additional icons are displayed to indicate different states:



indicates that CoCon server is connected to the Plixus Multimedia Engine



indicates an error state.



indicates a Master/Slave setup.



Control button key lock activation/deactivation. Press and hold control dial for 5 sec. You can still browse through the settings when locked.

Rear Connectivity

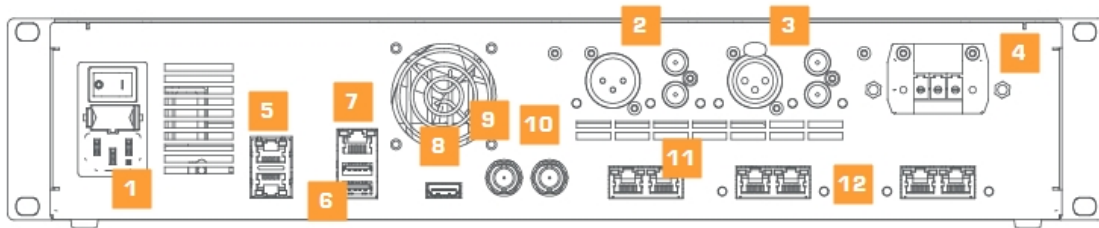

Figure 1-4 Plixus MME rear view

The rear of the Plixus MME/AE-R has the following connectivity options:

1. AC power inlet & fuse holder
2. Balanced (XLR) and two unbalanced (RCA) audio outputs
3. Balanced and (XLR) two unbalanced (RCA) audio inputs
4. 48 V power output (400 W)
5. Two redundant DANTE™ network ports
6. Two USB 2.0 ports (for future use)
7. IP configuration port (LAN)
8. Digital video output (HDMI) (for future usage)
9. SDI video input
10. SDI video output
11. Two back bone conference network ports that are not powered (for future use)
12. Four powered Plixus conference network ports

Dante™ Interface

The optional Dante™ card should be installed as follows:

1. Make sure the Dante card connectors face the top and put the card in under a 45° angle.



2. Press the card down and secure it with two screws, one at each corner of the card.



Please switch off power before inserting the DANTE™ card into the Plixus MME/AE-R.

Open the cover of the central unit and insert the card in the position as indicated in the picture. Fix the Dante™ card by means of two screws and put the cover back on the central unit.

Supported Video Formats

SD SDI	> PAL > NTSC
HD SDI	> 720p: 23.976, 24, 25, 29.97, 30, 50, 59.94 and 60 Hz > 1080p: 23.976, 24, 25, 29.97 and 30 Hz > 1080i: 50, 59.94 and 60 Hz
3G SDI	> 1080p: 50, 59.94 and 60 Hz

Factory Defaults Restore Button

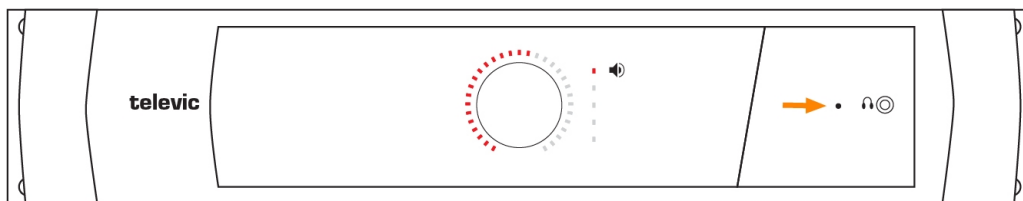

Figure 1-5 Reset button on Plixus MME

Depending on the amount of seconds you press and hold the reset button, different outcomes are possible:

- > Press and hold the button for **less than 5 seconds**: the units will restart.
- > Press and hold the button for **5 up to 20 seconds**: the IP address resets to the default IP address and the unit restarts. This is indicated by the blinking LED lights of the unit.
- > Press and hold the button for **more than 20 seconds**: configurations are not cleared, but inactivated, IP address is reset to the default IP address and the unit restarts. This is indicated by the continuously lit LED lights.

PLIXUS AE-R

Overview



Figure 1-6 Plixus AE-R front view

The Plixus audio engine is a 19" rack mountable device that provides audio processing and signal handling required for the Plixus network. It controls all delegate units and interconnects to other systems either via the external audio connections or control ports.

With the volume dial you can adjust the volume and using the record button you can easily start or stop recording the meeting. In contrast to the multimedia engine the Plixus AE-R does not have an internal power supply, meaning you will need at least one external power supply.

Recording Feature

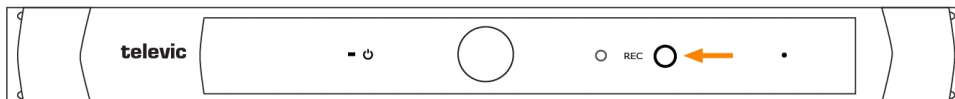

Figure 1-7 How to use the recording feature

With the Plixus AE-R you can record the floor and up to three different languages. You can use the button on the engine or the Plixus Core web server to control recording.

The LED next to the recording button shows the status of recording. The Plixus AE-R has an internal recording capacity of 8 GB. Depending on the selected bitrate you can record over 100 hours of audio. Use the USB port on the back to expand the recording memory.

You can download all Recorded meetings from the Plixus Core web server. There is an option to configure different recording features using the web server. See "Recording" on page 90 for more information.

Rear End Connectivity

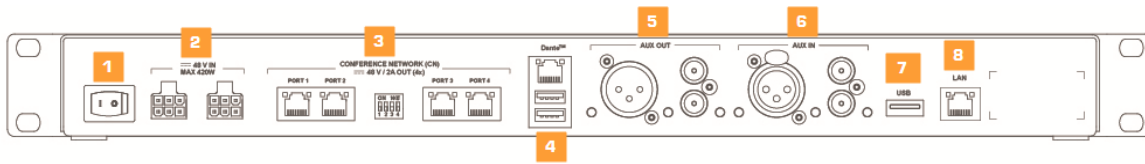

Figure 1-8 Back view of Plixus AE-R

1. On/off switch
2. Two power connectors for power supply injection
3. Plixus conference ports
4. Two redundant Dante™ network ports
5. Balanced (XLR) and two unbalanced (RCA) audio outputs
6. Balanced (XLR) and two unbalanced (RCA) audio inputs
7. USB 2.0 port to plug in USB device for audio recording
8. LAN port

Power Supply

The Plixus AE-R does not have an internal power supply. By default one external power supply of 220 W is delivered together with the engine. You can use a second power supply for redundancy. However for larger setups you need the additional power to power the units, preventing you to use the second power supply for redundancy. See "Power supply design" on page 53

Factory Defaults Restore Button

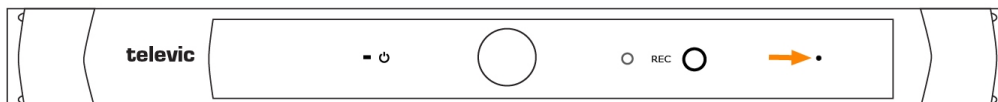

Figure 1-9 Reset button on Plixus AE-R

Depending on the amount of seconds you press and hold the reset button, different outcomes are possible:

- › Press and hold the button for **less than 5 seconds**: the units will restart.
- › Press and hold the button for **5 up to 20 seconds**: the IP address resets to the default IP address and the unit restarts. This is indicated by the blinking LED lights of the unit.
- › Press and hold the button for **more than 20 seconds**: configurations are not cleared, but inactivated, IP address is reset to the default IP address and the unit restarts. This is indicated by the continuously lit LED lights.

PLIXUS POWER SUPPLY

The Plixus MME has an internal power supply of 48 V/10 A (480 W). However the Plixus AE-R does not. By default you receive one Plixus power supply with the AE-R. When the internal power supply of the MME or the external power supply of the AE-R is insufficient, a separate power supply is necessary.

For more information on how many power supplies your system requires see "Power supply design" on page 53.

Plixus AE-R Power Supply

In contrast to the MME the Plixus AE-R doesn't have an internal power supply. By default the Plixus AE-R comes with one external power supply.

Plixus Power Supply

The power supply is a 19" rack mount version. The front panel is equipped with a rocker mains switch with built-in indicator and two mains fuses.

The use of an additional power supply is needed when the internal power supply of the Plixus MME/AE-R is insufficient.

The 230 V mains is connected to the power supply through a male connector (1) at the back of the power supply. A power good TTL output on a D9 connector (2) allows you to check whether the power is okay. Six female Phoenix connectors (3) are available to branch off the 48 V.

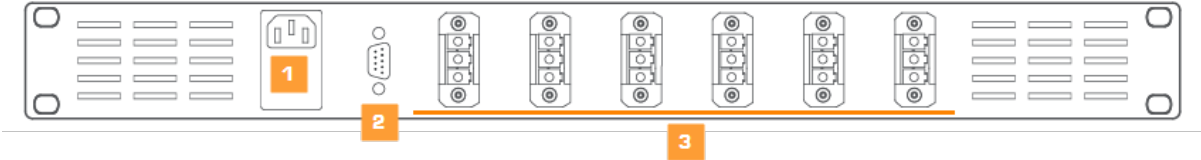
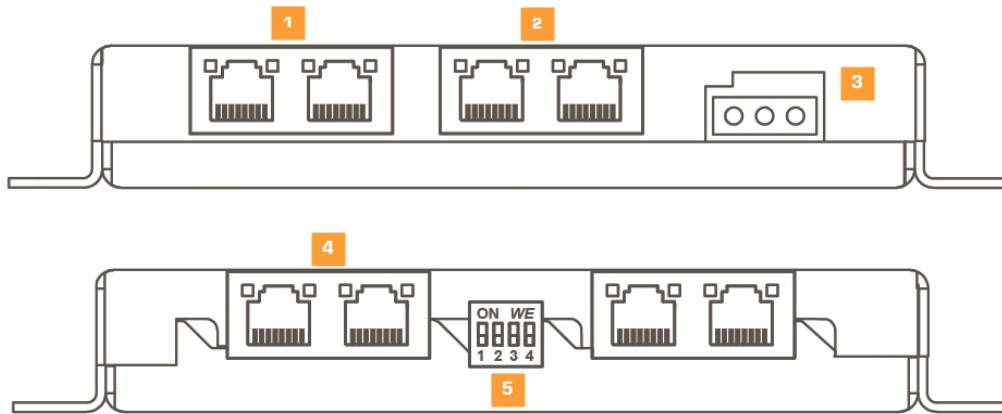

Figure 1-10 Rear power supply connections

PLIXUS NEXT

Plixus NEXT is the next generation of Plixus network extenders which have the same functionality and connectivity, but additionally offer the option to configure (via DIP switches) a delayed power up of the conference extension ports (see DIP switch table below).



1. Two Plixus network conference ports (uplink).
 - a. Gives Plixus network signal to conference extension ports of the central engine or other network extender.
 - b. Allows connection in branch / loop.
2. LAN ports are not used.
3. 48 V power supply: powers the four conference ports.
4. Four Plixus network conference ports (downlink).
5. DIP switches enable / disable power of conference ports and allow sequential startup.

DIP Switch Table

DIP switch settings				Ports powered at startup	Startup delay of first port(s)	Port interval(s)	Remark
1	1	1	1	All ports	0	0	Standard settings
0	0	0	0	None	NA	NA	No power, only data. Switches activated after startup, will power corresponding ports
1	0	0	0	Port 1	0	NA	1 port powered
0	1	0	0	Port 1 + 2	0	0.5	2 ports powered
1	1	0	0	Port 1 + 2 + 3	0	0.5	3 ports powered
0	0	1	0	All ports	0	0.5	delay 0 to 1.5
1	0	1	1	All ports	2	0.5	delay 2 to 3.5
0	1	1	0	All ports	4	0.5	delay 4 to 5.5
1	1	1	0	All ports	6	0.5	delay 6 to 7.5
0	0	0	1	All ports	8	0.5	delay 8 to 9.5
1	0	0	1	All ports	10	0.5	delay 10 to 11.5
0	1	0	1	All ports	12	0.5	delay 12 to 13.5
1	1	0	1	All ports	14	0.5	delay 14 to 15.5
0	0	1	1	All ports	16	0.5	delay 16 to 17.5
1	0	1	1	All ports	18	0.5	delay 18 to 19.5
0	1	1	1	None	NA	0	Remote control*

*planned for future releases

General Network Extender Guidelines

- › The maximum distance between the central unit and the first Plixus network extender or delegate unit in the branch is 100 m.
- › The maximum distance between two Plixus network extenders is 100 m.

- > The Plexus network extender must be powered externally (through power supply of Plexus MME or Plexus power supply).
- > One branch or loop cannot consist out of more than 8 Plexus network extenders (for optimized packet propagation)
- > One branch or loop may consist of no more than 20 Plexus devices (less if power is limiting factor).
- > Restrict a downlink port branch to 1 network speed: 100 Mbit or 1 Gbit!

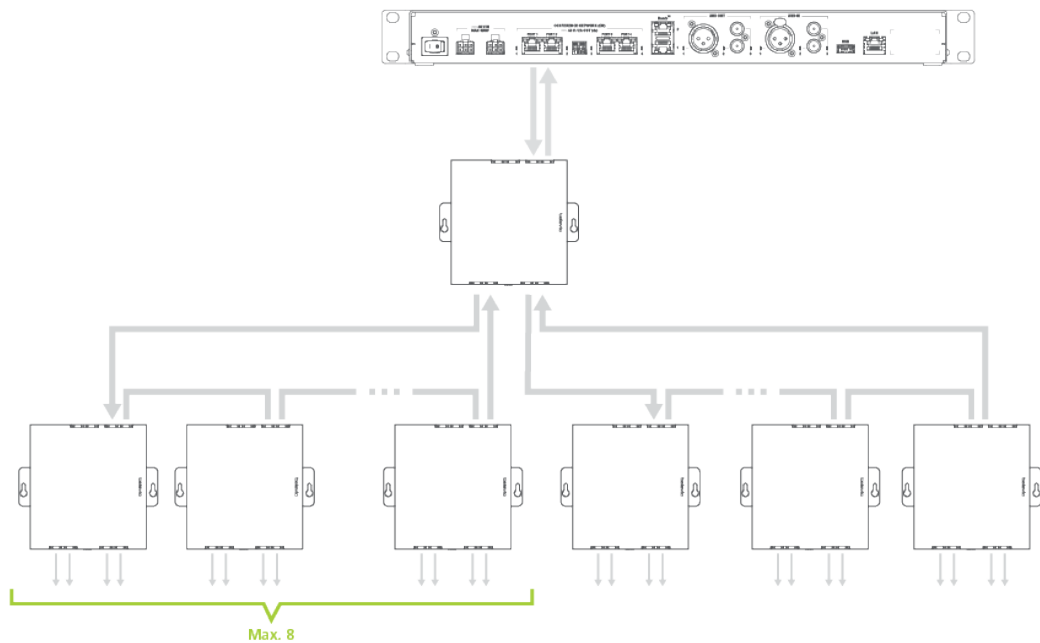

Figure 1-11 Example network extender configuration

Redundancy

In Plexus it is possible to insert a type of fail-safe mechanism by creating redundancy. You can get redundancy by inserting loops in your network. When there is a loop, Plexus can still access the device using a different route when a cable or a device in one side of the loop breaks.

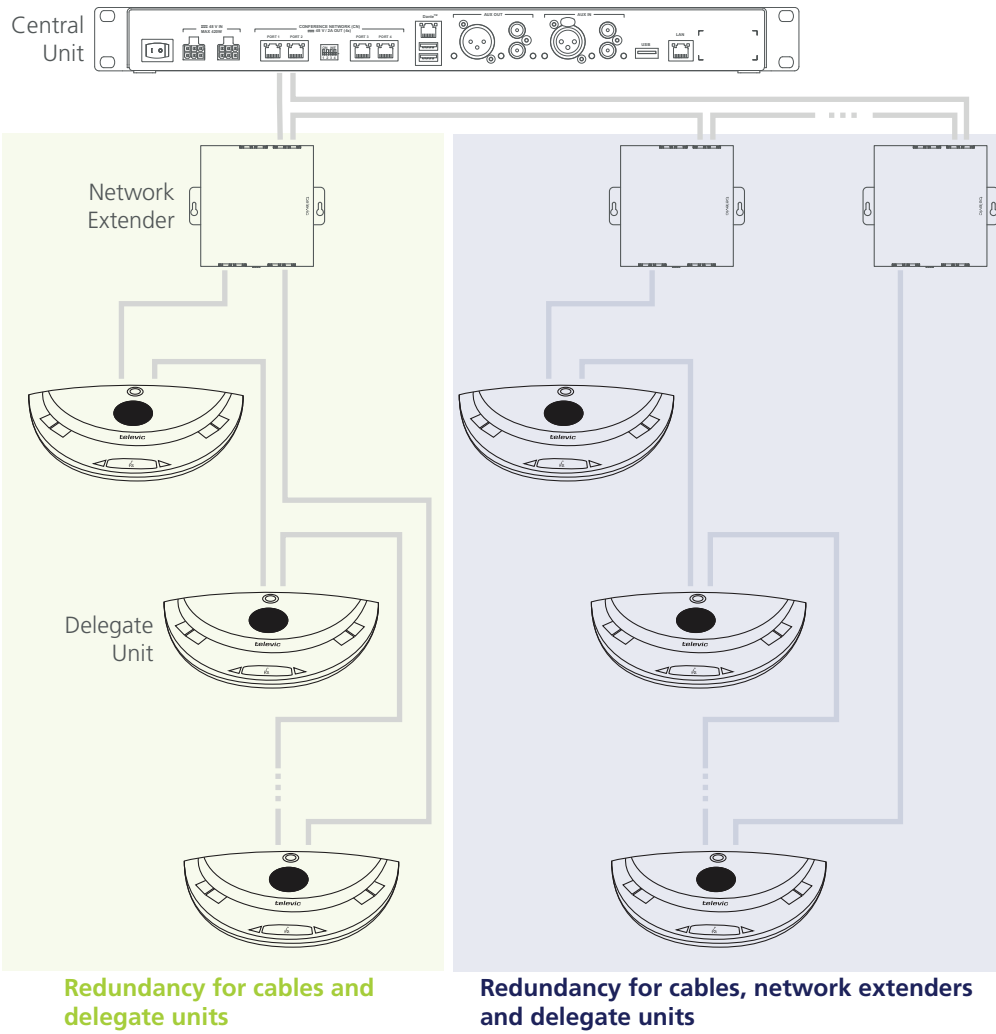

Figure 1-12 How to create redundancy using a network extender.

VIDEO-IN

Video-In Box

Through the Plixus Video-IN (V-IN) box you can insert a HDMI video stream anywhere in the Plixus network. There are two modes available for the V-IN box:

- > Fixed routing
- > Push to show

You can use multiple V-IN boxes in a Plixus network. Group V-IN boxes in order to create a presentation stream based on a push to show principle (using the Video-Request button or dry contacts). A total of six streams can be active in the Plixus network at any given time.

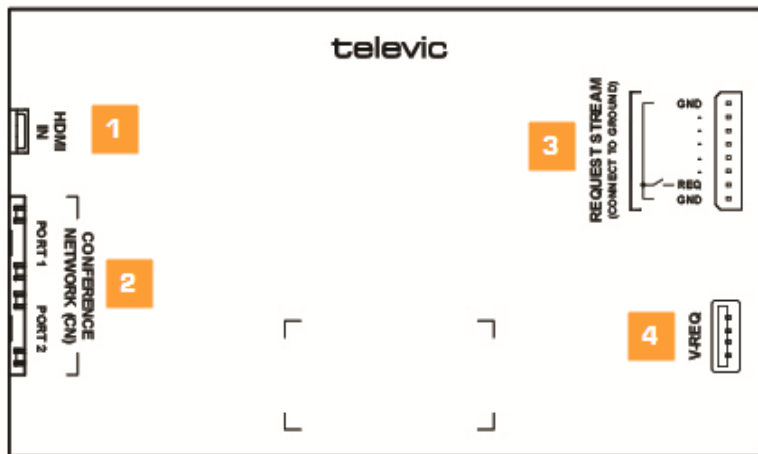

Figure 1-13 Video-IN box

1. Insert HDMI video stream
2. Two Plixus conference ports
3. Dry contacts for video stream input request
4. USB connection to V-REQ



The USB connection for the V-REQ is not a standard USB connection. This connection only works for the V-REQ.

The V-IN box supports the following formats:

- > 1920×1080p60
- > 1920×1080p30
- > 1280×720p30
- > Interlace is not supported

Video Request

The video stream input request can be done via dry contacts or by using the Plixus V-REQ (video input request button), see image below.

Connection of V-REQ to the Video In Box is done through the included micro USB cable.

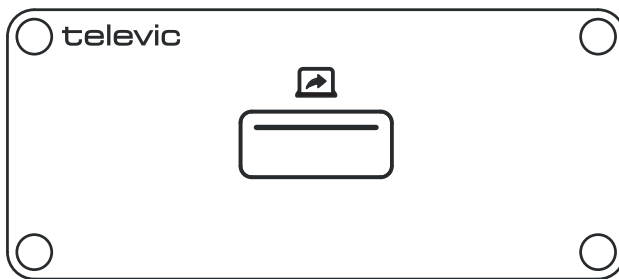

Figure 1-14 Video-Request button

VIDEO-OUT

Video-Out Box

You can use the Plixus Video-OUT Box to extract any HDMI video stream from the Plixus network to an external device using HDMI. Two modes are available:

- › fixed stream routing
- › selection of available streams (using Video-Selection (V-SEL) or dry contacts)

You can assign multiple V-OUT boxes to a group, routing a specific stream to these boxes.

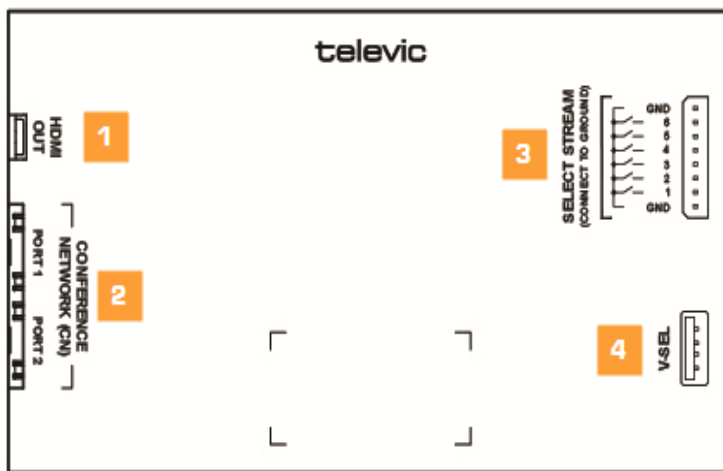

Figure 1-15 Video-OUT box

1. HDMI OUT connection
2. Two Plixus conference ports
3. Dry contacts for video stream selection (six streams available)
4. USB connection for V-SEL



The USB connection for the V-SEL is not a standard USB connection. This connection only works for the V-SEL.

The V-OUT box supports the following formats:

- > Supports all resolutions with a maximum of 1920x1080p60
- > Interlace is not supported

Video Selection

Video stream selection can be done via dry contacts or by using the Plixus V-SEL accessory. Connect the V-SEL to the Video-OUT Box is done through the included micro USB cable.

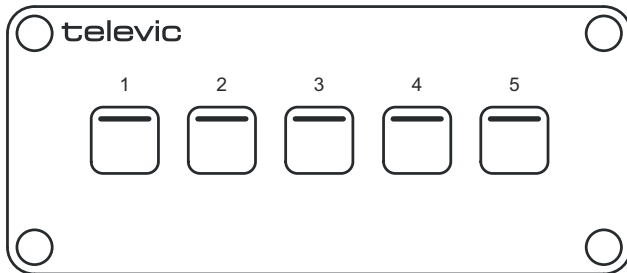

Figure 1-16 Plixus V-SEL accessory

VIDEO STREAM ROUTING

You can configure video stream routing using the CoCon Video application (CoCon & Plixus CRP version ≥ 5.0).

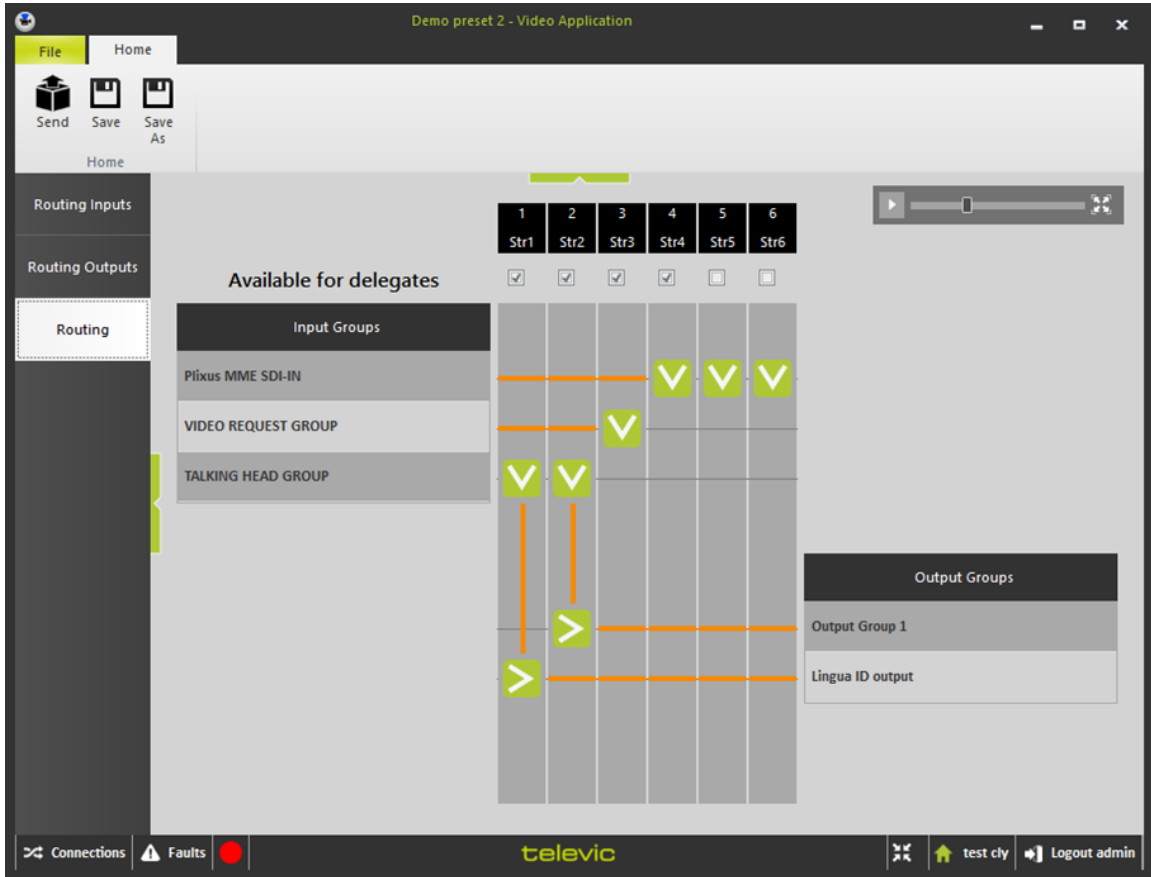

Figure 1-17 Configure video stream routing in CoCon

In the application you can define the video input and create input groups (shown on the left side of the figure). In the middle you can see the six available video streams, you can change the name of each of these streams. Disable streams by unchecking the option **Available for delegates**, these streams will not be available for the V-SEL.

Assign a specific input to one or more streams, the downwards arrow indicates that the input is put on that video stream. The output is shown on the right side, the arrow pointing to the right indicates that the video stream is connected to the output.

See CoCon user guide for more information.

DELEGATE EQUIPMENT

You can add different types of units and other peripherals to your Plixus architecture depending on your requirements. Below you can find a list of all delegate equipment that you can combine with Plixus together with a short description.

Audio Only Equipment

Product	Description
Confidea (tabletop or flushmount)	The audio only unit of the Plixus network.
Lingua interpreter desk	Unit specifically designed to support interpretation. This unit only supports audio.

Multimedia Equipment

Product	Description
uniCOS (7" or 10")	The touch screen multimedia unit. Allows delegates and chairmen to see additional information, video, but also documents that are relevant for the meeting or the agenda.

Advanced Delegate Equipment

Product	Description
Plixus Nameplate	Is a double sided nameplate based on E-ink technology which automatically updates the display when delegates sign in or by input of the conference manager. Daisy chain to connect to the Plixus network connect directly to multimedia units using USB. Use the CoCon Nameplate software to configure the nameplate.

For more information on how to use these different peripherals consult their dedicated user guides. How to set them up in the Plixus network is explained in the chapter "[Installation design](#)" on page 42.

INTERPRETER EQUIPMENT

Within the Plixus network it is possible to configure interpretation. Different units are available for interpreters. Below you can find a list of all these units, together with a short description.

Product	Description
Lingua interpreter desk (video enabled)	Unit specifically designed to support interpretation. In the video enabled version you can extract video from the units HDMI output.
Lingua Interpreter desk (Audio)	Unit specifically designed to support interpretation, that does not support video.

PLIXUS COMPONENT PROPERTIES

It is not possible to combine all Plixus components on the same branch because some units are **powered over the Plixus cable**, while others require external power.

In addition there is a difference in network speed for audio-only devices versus multimedia devices. As a consequence, three different categories of devices are possible that you cannot mix on the same branch.

The following tables list the properties of all components. Please note the different categories:

- **100 Mbit powered over Plixus Cable**
- **1 Gbit powered over Plixus Cable**
- **1 Gbit externally powered**

100 Mbit Powered Over Plixus Cable

Component type	Plixus Network Speed	Power over Plixus cable	Max Power Consumption
Confidea F	100 Mbit	+	5 W
Confidea T	100 Mbit	+	5 W
Confidea CS	100 Mbit	+	2 W
Lingua ID (audio only)	100 Mbit	+	11 W
Confidea G3 WCAP	100 Mbit	+	10 W
Plixus Nameplate	100 Mbit	+	3 W

1 Gbit Powered Over Plixus Cable

Component type	Plixus Network Speed	Power over Plixus cable	Max Power Consumption
Lingua ID (video)	1 Gbit	+	12 W
Confidea F-DIV-C	1 Gbit	+	12 W
Video Out Box	1 Gbit	+	7 W
Video In Box	1 Gbit	+	7 W

1 Gbit Externally Powered

Component type	Plixus Network Speed	Power over Plixus cable	Max Power Consumption
uniCOS 7" F/MM	1 Gbit	-	15 W
uniCOS 10" F/MM	1 Gbit	-	15 W
Plixus NEXT	100 Mbit / 1 Gbit	-	7 W



A branch cannot mix products with different network speeds. A single branch is restricted to components from one and the same category.

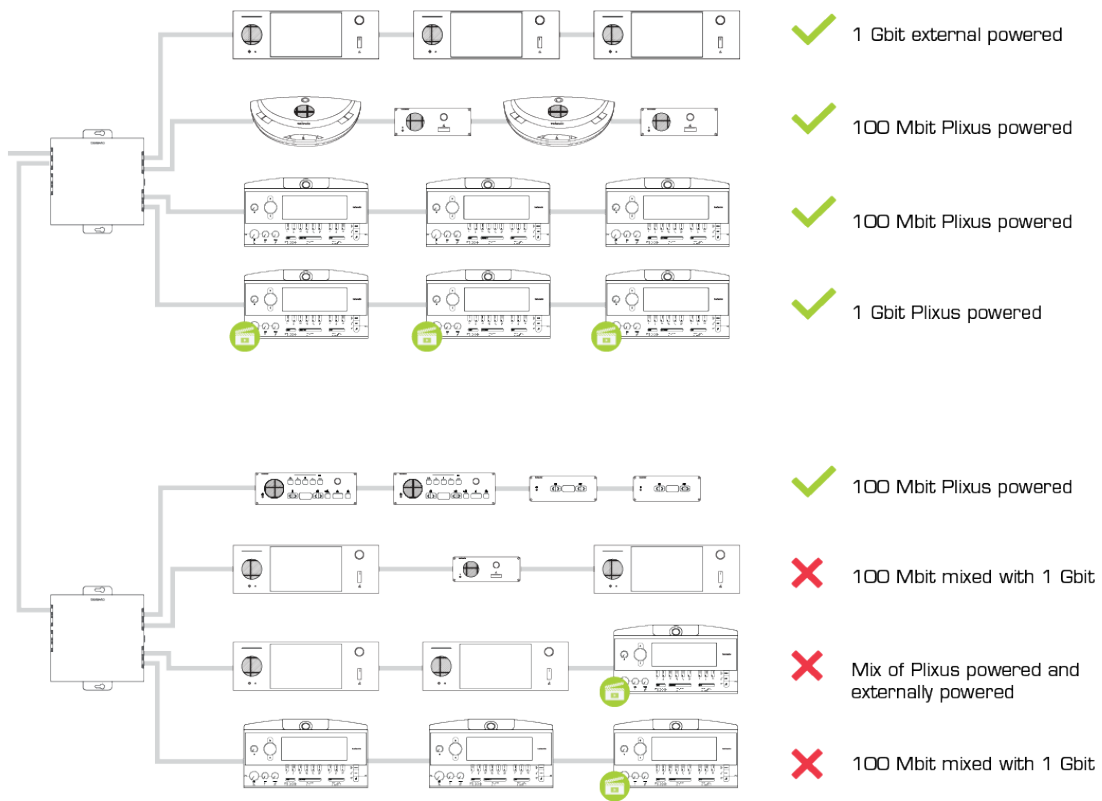

Figure 1-18 Dos and don'ts of combining units



It is strongly recommended to only place Plixus Network Extenders in one branch, and not to mix them with uniCOS Multimedia units (although they belong to the same category).

GENERAL INSTALLATION GUIDELINES

The following installation design rule apply for one branch / loop powered only by the Plixus engine (internal 48 Vdc power supply) or an external Plixus Power Supply:

- › A maximum of 100 W
- › A specific maximum of devices per product family per branch / loop
- › A maximum cable length between two units of 100 m

Units Per Branch / Loop

Depending on the type of unit we advise to add a maximum amount of devices per branch. This is to ensure that the last device in the branch receives enough power (only for devices powered over Ethernet) and limit delay data transmission.

In the table below you can see the maximum allowed devices per branch.

Device type	Max. number per branch
Confidea T/F	20
Confidea F channel selector	30
uniCOS F/MM	30
Lingua Interpreter Desk	8
uniBox	30
Video IN / OUT	8
Plixus NEXT	8
Confidea G3 WCAP	8
Confidea F-DIV-C	8
Plixus Nameplate	8

When To Use A Network Extender

When the four Plixus conference ports provided by the engine are insufficient for your system, you can extend your range by using network extenders (Plixus NEXT). A network extender has four additional conference ports, which allows you to add much more units to your network.

There are two possible configurations to use these network extenders, you can daisy-chain them or put them in a tree structure. When you daisy-chain network extenders you can use a maximum of eight extenders per branch. In a tree structure there are no limitations. See "Installation diagram" on the next page for a schematic representation of these cases.

INSTALLATION DIAGRAM

Configuration With Plexus Engine Only

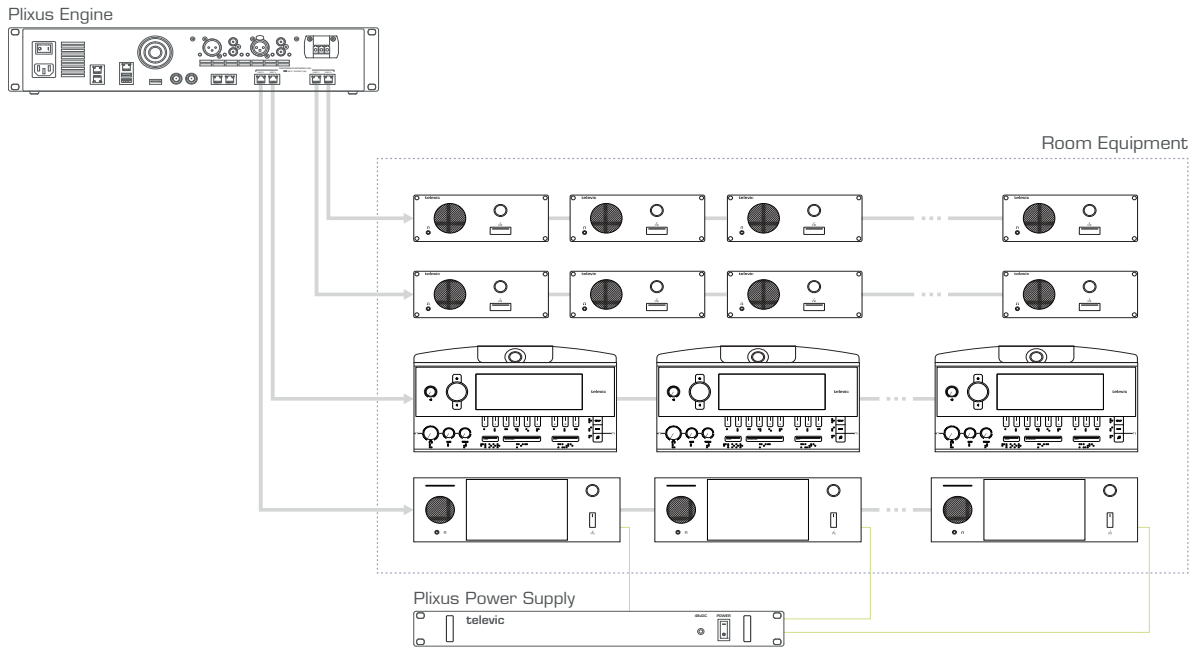

Figure 1-19 Example of Plexus network with engine only

For a setup where you only need an engine, connect the units directly to the conference ports of the Plexus engine. Daisy chain the different units in the branch. If your system contains uniCOS units, you need an external power supply.

Only mix compatible units in one branch. For more information on which units you can combine see "Plixus component properties" on page 43. In this table you can also see the power consumption, which you need to know how many units you can have in one branch. Use the power calculator tool to validate your configuration ("Power supply design" on page 53).

Configuration With Network Extender

DAISY-CHAIN NETWORK EXTENDERS

When you daisy-chain network extenders, you can have a maximum of 32 network extenders (eight per branch and this for the four Plexus conference ports).

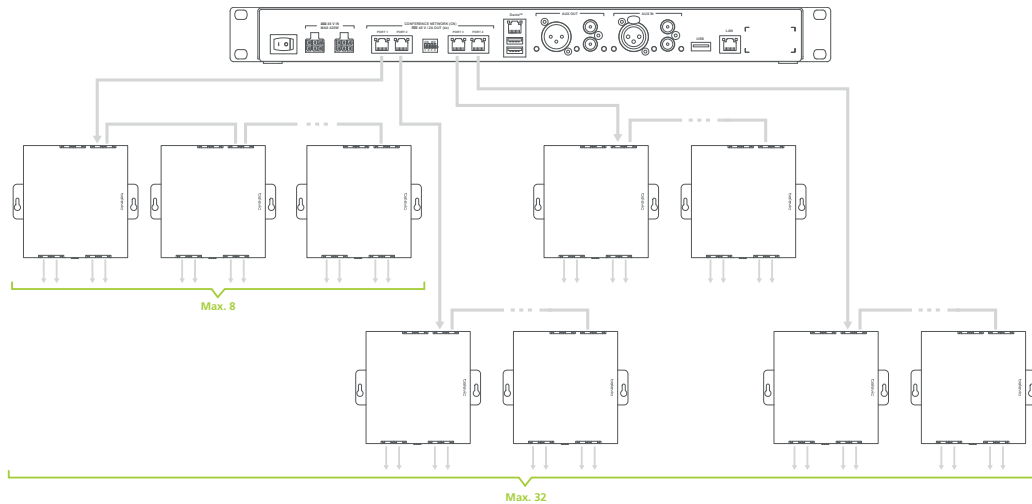

Figure 1-20 How to put network extenders in daisy-chain configuration

To create redundancy in your system you can insert loops (see "Plixus NEXT" on page 31)

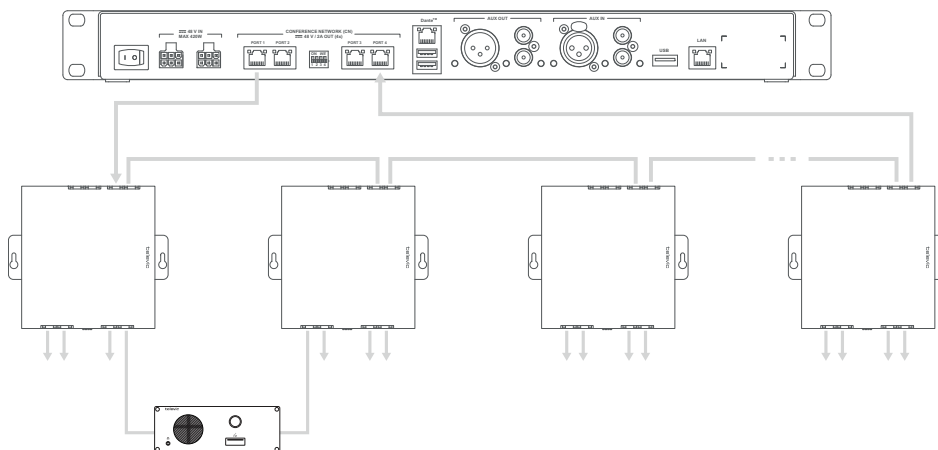

Figure 1-21 Plixus network with daisy-chained network extenders and loops

TREE STRUCTURE OF NETWORK EXTENDERS

For larger setups you can put the network extenders in a tree structures. Here there is no limitation on the amount of network extenders you can put in the tree.

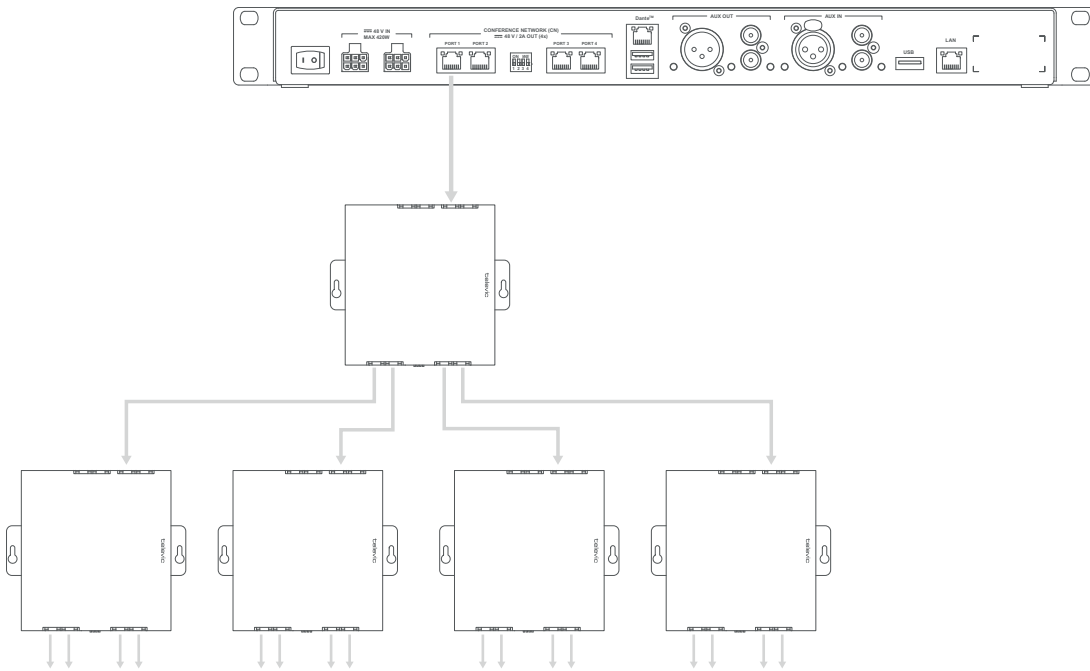

Figure 1-22 How to use network extenders in a tree structure

You can also create redundancy in a tree structure, the figure below shows you how to achieve this.

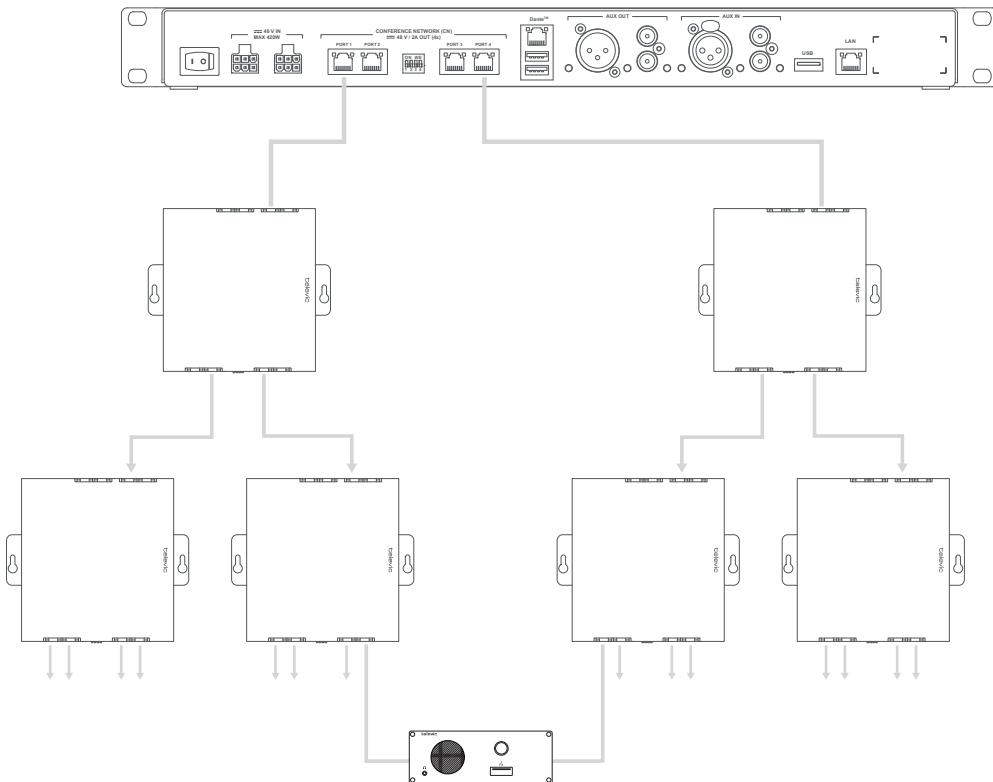

Figure 1-23 Plixus network with network extenders in tree structure and with loops

PLIXUS SETUP WITH NETWORK EXTENDERS

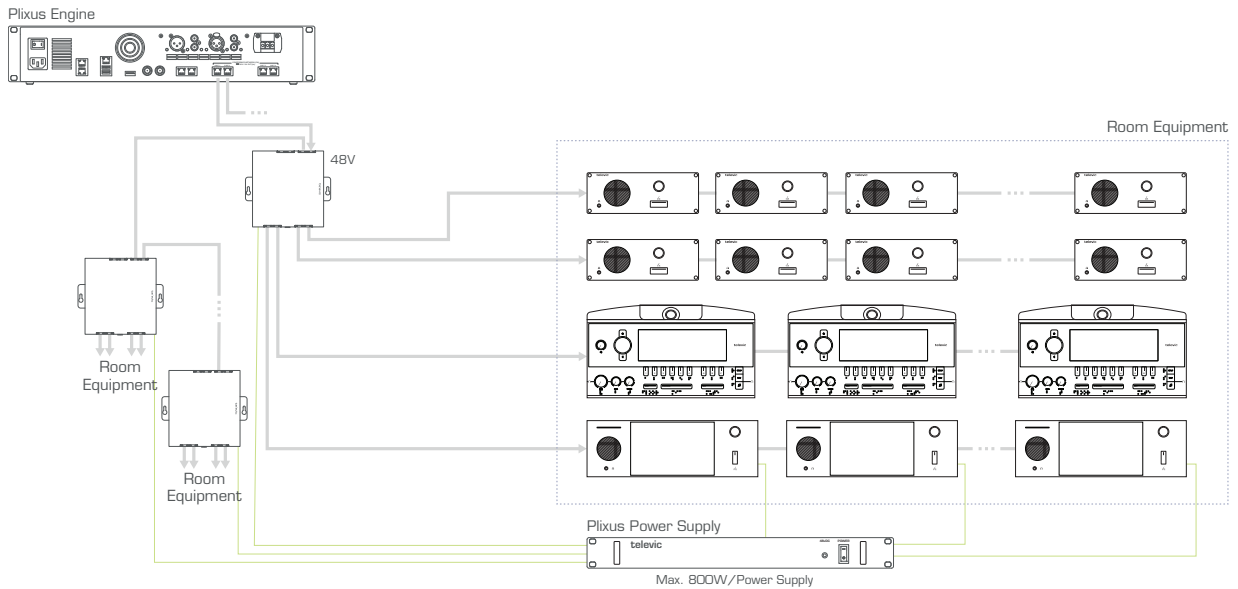

Figure 1-24 Example of Plixus network with network extenders

For installation with a network connector, use the conference port on top of the network extender to connect with the Plixus engine. Use the second top conference port to form a daisy chain with another network extender. Use the conference ports on the bottom of the extender to connect the units inside the room. To connect the extender to the units the same principles apply as for the direct connection of the engine to the units. See "Configuration with Plixus engine only" for more information.

The network extender and uniCOS units require an external power supply. There is a maximum of power that the power supply can foresee. Use the power calculator tool to see how many power supplies you require ("Power supply design" on page 53).



The Plixus AE-R does not have an internal power supply and comes with one power supply of 220 W by default. Check the table with power consumption details and use the power calculator tool to check how many power supplies you need. You can find more information on the power needed for your system in "Power supply design" on page 53.

Examples

EXAMPLE WITH 50 CONFIDEA F UNITS

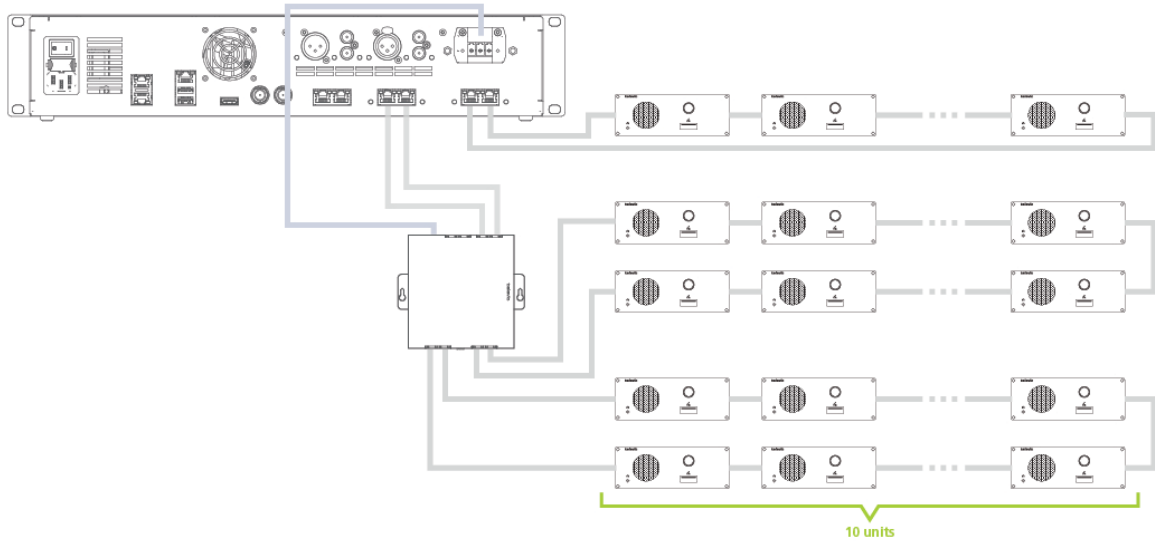

POWER SUPPLY DESIGN

Power Availability And Consumption Table

Power availability	
Plixus MME total power supply	500 W (400 W available for Plixus ports)
Plixus AE-R power supply	220 W
One single Plixus port allows	100 W (engine ports or extension ports)

Maximum power consumption	
Confidea FT	5 W
Confidea CS	2 W
uniCOS 7 "	15 W
Plixus NEXT	7 W
Lingua Interpreter Desk - Audio only	11 W
Lingua Interpreter Desk - Video	12 W
Video-IN / Video-OUT box	7 W
Confidea WCAP	10 W
Plixus Nameplate	4 W
Maximum distance between units	100 m (signal regenerated in every unit)
Minimum required voltage per unit	36 V



The general rule states that you should use a maximum **20 delegate units per branch / loop**.

Plixus AE-R Power Supply

The Plixus AE-R does not have an internal power supply, however it does have two power connectors. By default you get one power supply together with the engine. You can extend this power supply with another as redundancy or when the system requires more power.

To check how many power supplies you require, consult the flowchart shown below.

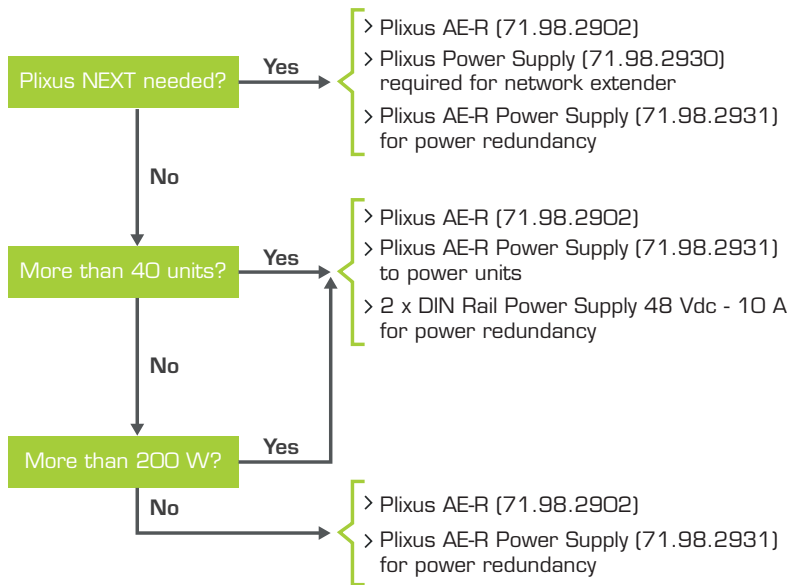

Figure 1-25 How to decide to need an additional Plixus AE-R power supply

Calculator Tool



The Plixus Power Calculator Tool allows you to validate a configuration in more detail. It takes into account the network cable lengths, power cable lengths and the different types of equipment.

The Plixus Power Calculator Tool can be easily found on the Televic Partner Domain.

Regardless of the calculator values, the maximum values above still apply. If more units, more power or a larger length is needed, then you need to create a separate branch using a Network Extender.

Cable Requirements



Televic advises to use minimum **CAT 5e F/UTP 23 AWG** for **run cables** and **CAT 5e F/UTP 24 AWG patch cables**.

Televic strongly advises that cables for all **video-enabled products** are created in **loop**.

Please follow the cable guidelines described here, they are important to guarantee correct system performance.

- › Keep all cable runs **under 90% of the maximum distance** supported for each media type as specified in the relevant standard. This extra headroom is for the additional patch cables that will be included in the end-to-end connection.
- › Always use the **same type of cable** (except AWG) in the end-to-end connection.
- › Cabling installations and components should be compliant with the **ISO/IEC 11801 standard**.
- › **Do not stress the cable** by doing any of the following
 - › Applying additional twists
 - › Pulling or stretching beyond its specified pulling load rating
 - › Bending it beyond its specified bend radius
 - › Creating tension in suspended runs
 - › Stapling or applying pressure with cable ties
- › **Avoid** placing **copper cables** near equipment that can generate high levels of **electromagnetic** interference. Generally avoid locations near power cords, fluorescent lights, building electrical cables and fire-prevention components.
- › Use the **Plixus Power Calculator** to ensure sufficient power for all units in the network.

COMBINE PLIXUS WITH CONFIDEA G3

Combine Wired And Wireless Units

With Plixus it is possible to combine wired and wireless units this can be the case when disabled people require a wireless microphone. You can also use the wireless units to extend the amount of people that can join the meeting. A third reason to combine wired and wireless, is to use the wireless system as backup.

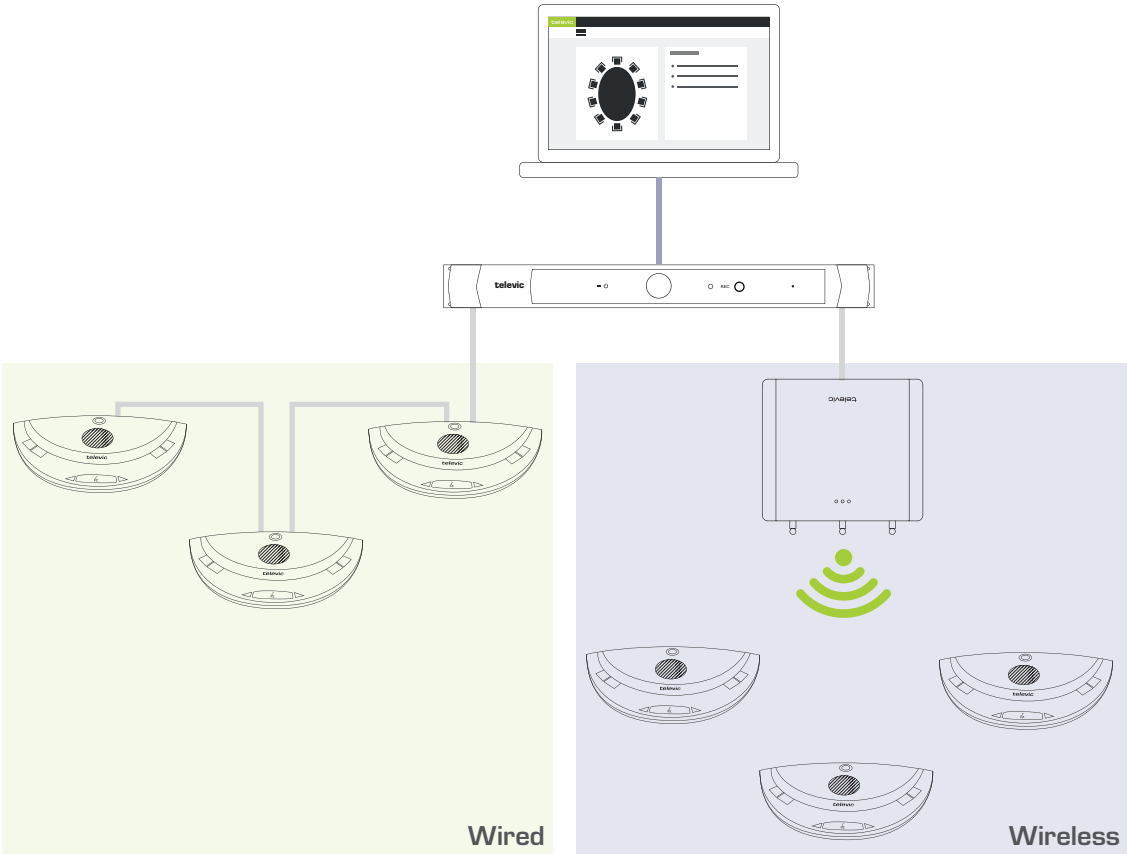

Figure 1-26 How to combine wired and wireless units in a single Plixus setup

Combine Interpretation With Wireless Units

In the Confidea G3 unit product range, multiple units that can support that support channel selection are available. Couple such units with the Plexus engine to receive the channels from the Lingua Interpreter Desks in your Plexus network.

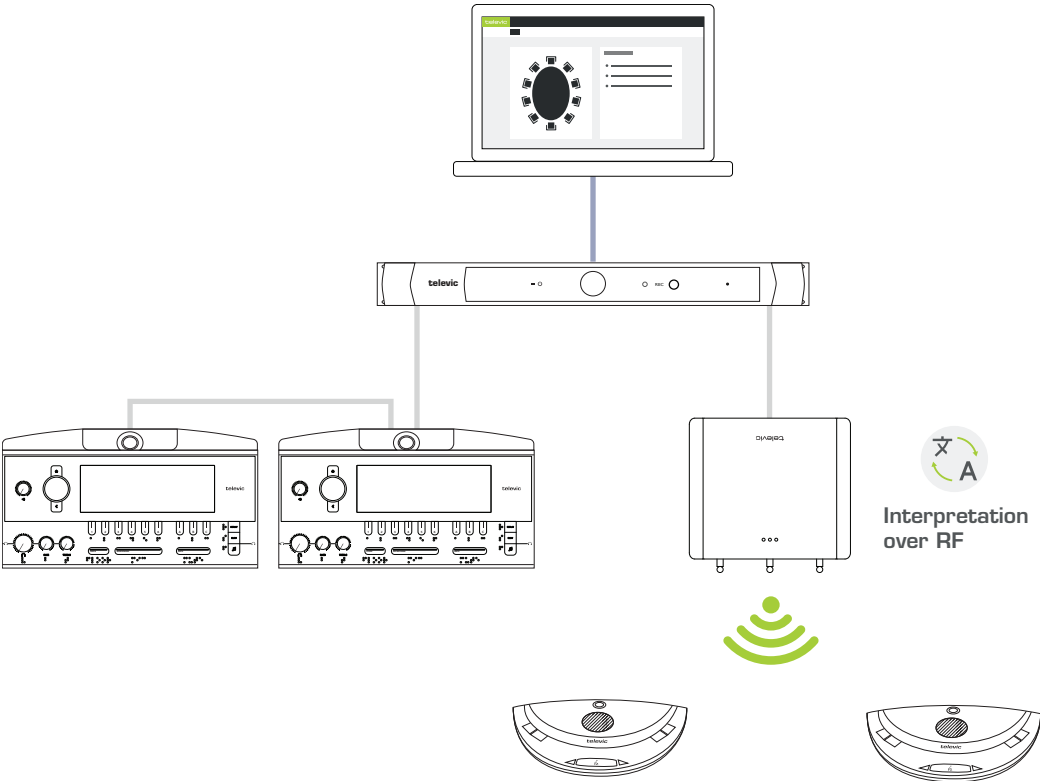

Figure 1-27 How to distribute languages using radio frequency

Range Extension With Multiple Access Points

Improve the range of your room by using multiple WCAPs. By using multiple WCAPs you are able to connect to much more units spread out over the entire meeting room. For more information on how to position the WCAPs for optimal transmission see the Confidea G3 dedicated user guide.

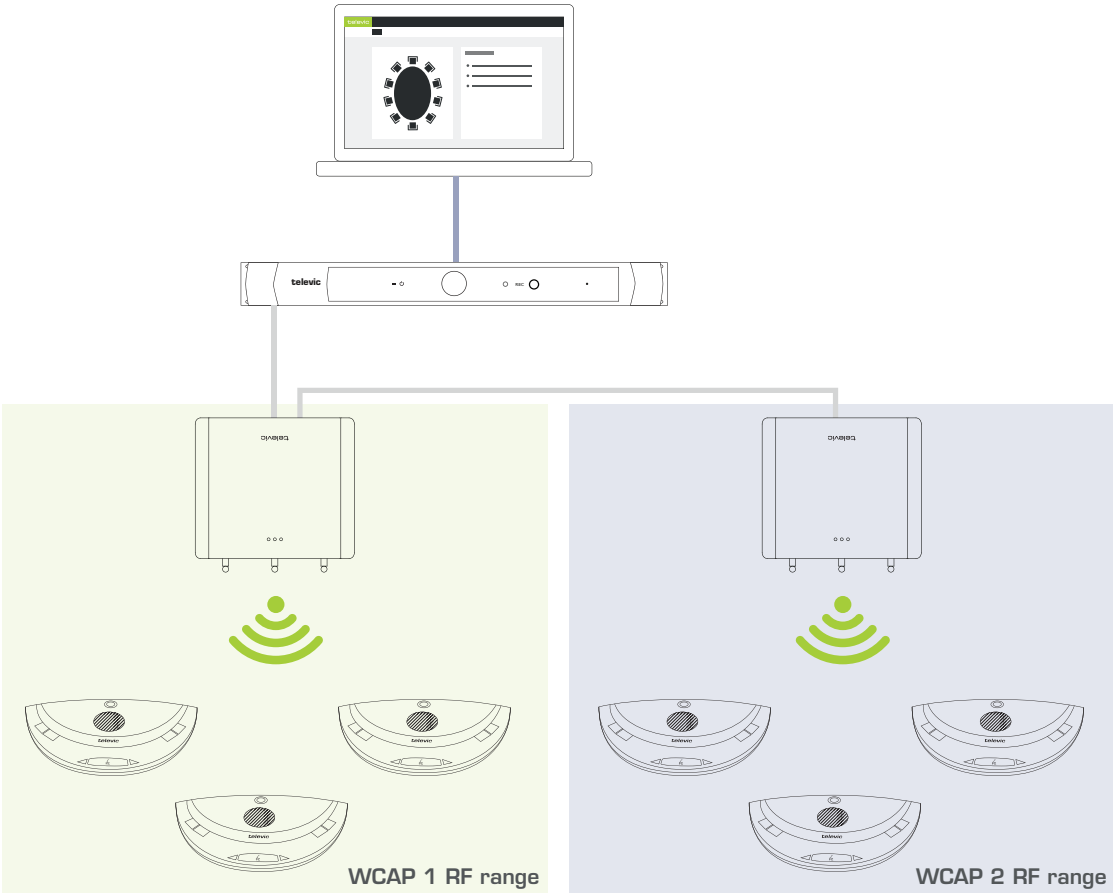

Figure 1-28 Improve the range of your system by using multiple WCAPs

Split And Combine Rooms

Use the WCAP in standalone mode for small meetings. For larger meetings you can combine multiple rooms by coupling the WCAPs with the Plexus engine. In this way you can manage all units centrally using the Plexus engine and web server.

When you need to split the room again, simply uncouple the WCAP from Plexus. The WCAP will go back to standalone mode where it remembers all its previous settings.

The Plexus engine will remember the WCAPs once they were coupled. Just couple them using the web server whenever you need to combine rooms.

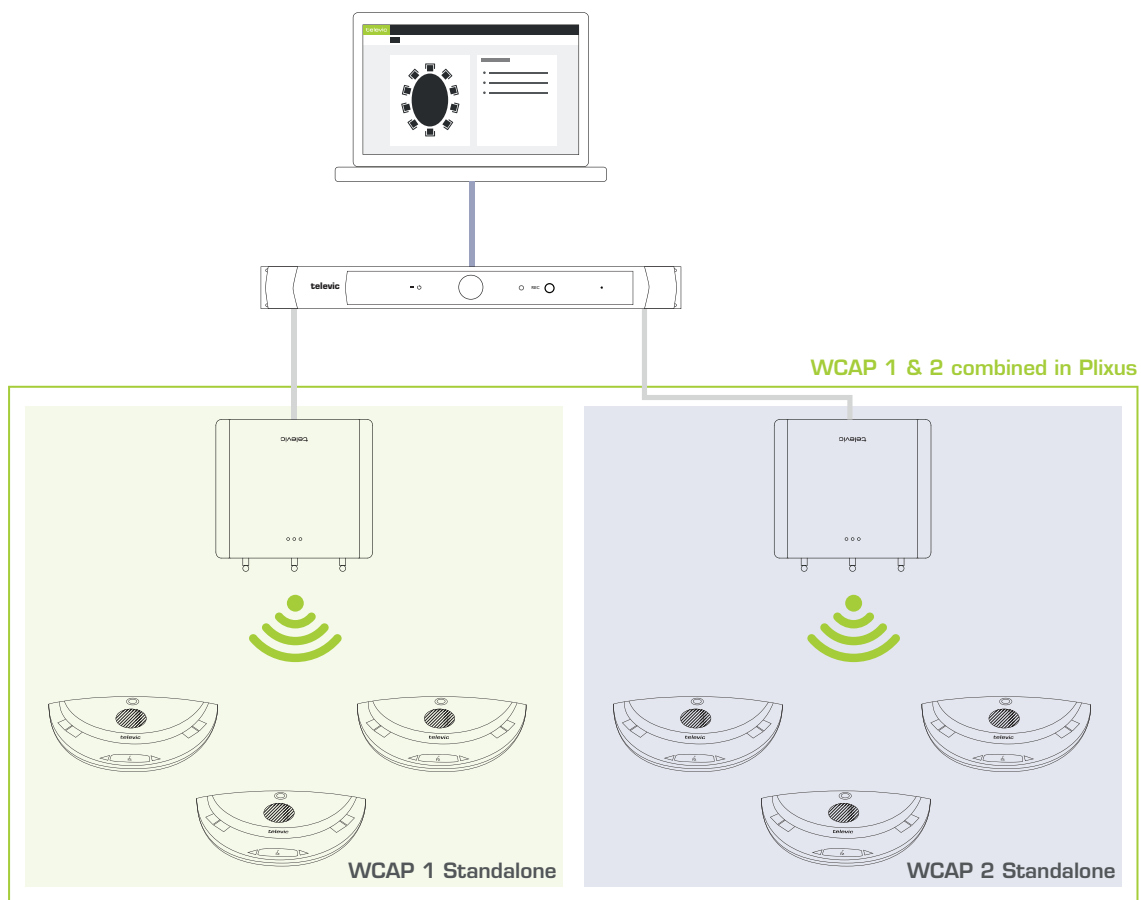

Figure 1-29 Use the WCAPs in standalone mode when you need to separate rooms or combine to rooms into one by coupling the WCAPs to the Plexus network.

Create Redundancy

Use multiple WCAPs to create redundancy. When one WCAP fails you can easily switch to associated units to another empty WCAP using the web server. See "Couple with Confidea G3" on page 110

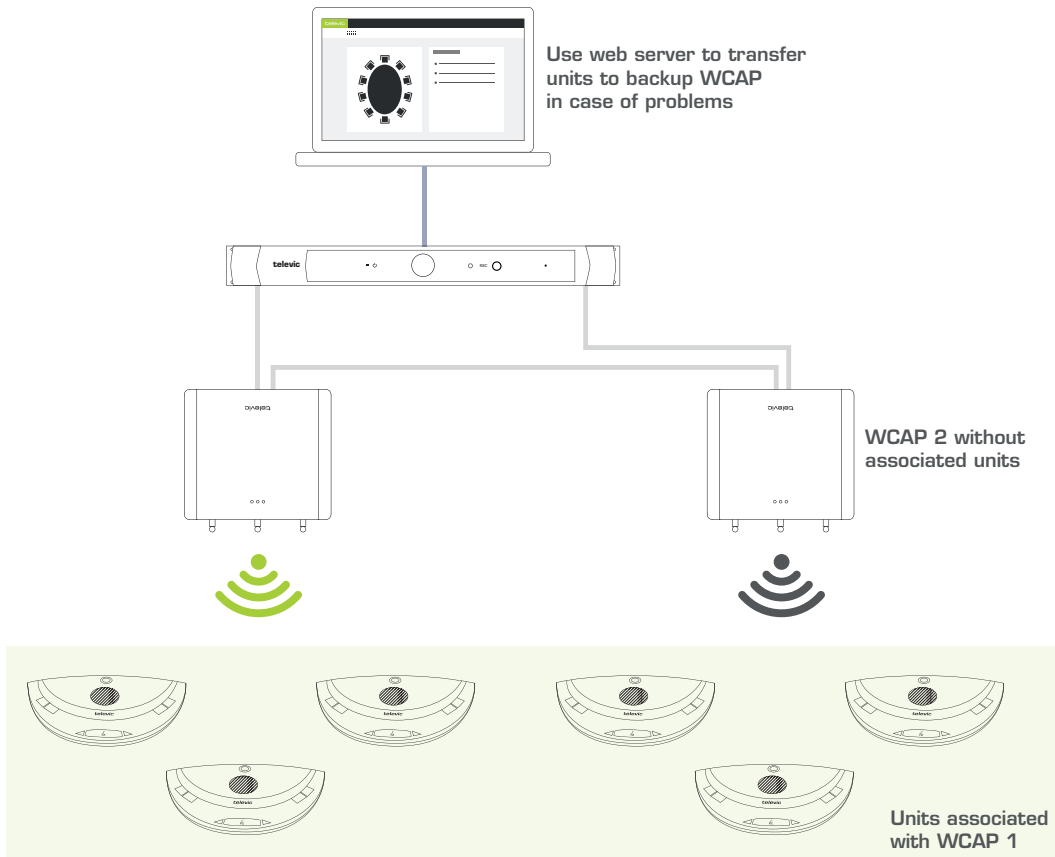

Figure 1-30 Create redundancy by having a backup WCAP in your Plixus system with no associated units. Transfer units in case of problems to this backup WCAP by using the Plixus Core web server.

INSTALLATION PROCESS

This chapter describes how to physically set up and install the Plexus network. Here you can find all technical details needed to correctly install all Plexus components.

INTRODUCTION



Before you start, make sure to take all necessary precautions. Refer to the tables above and ensure all components are installed and sufficiently powered.

Before you install the Plixus system, make installation design as described in "Installation design" on page 42 to ensure correct installation. In this design you will calculate the following elements:

- › The system Power consumption
- › The amount of external power supplies needed
- › Cable length needed

POWER SUPPLY

Power UniCOS Units, Network Extenders And UniBOX

To supply power to the uniCOS units, network extenders, and uniBOXes, 48 VDC is required. A WAGO Power Connector supplies the necessary power. It is advised to use strain reliefs.

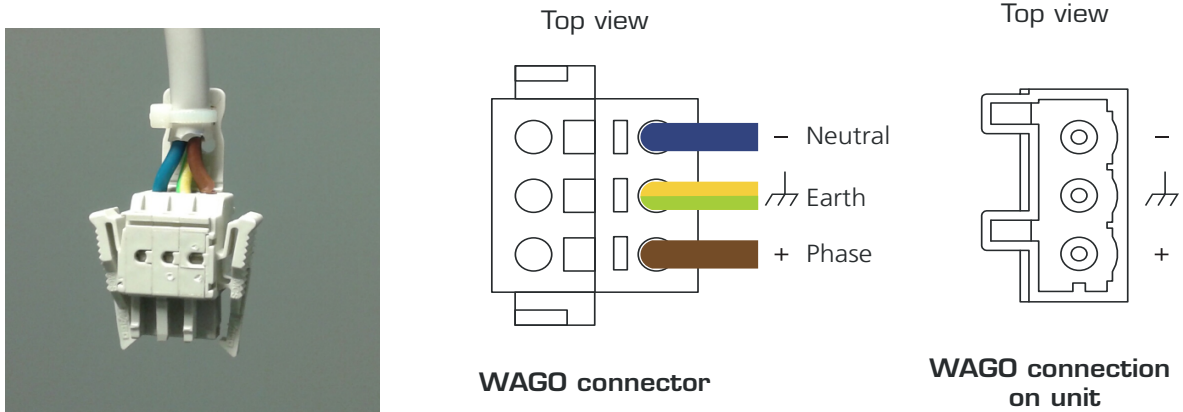

Figure 1-31 WAGO connector together with the connection available on the devices



Each power connector has two interfaces with three contacts that allows you to daisy chain units.



When connecting the power cables, please note the correct order of the cables and their corresponding colors, see the picture above.

Power Supply Of The Central Unit



When connecting power at the back of the central engine, please note the correct order of the cables and their corresponding colors

PLIXUS AE-R

To supply power to the Plixus AE-R using the power outlets on the engine. You can add two 220 V power supplies. Use a second one when 220 V is insufficient or as a redundant power supply.

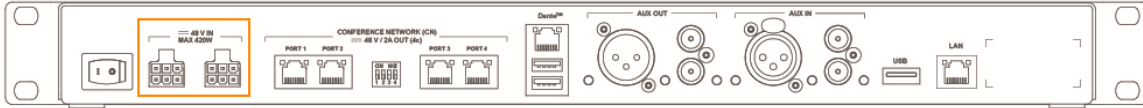

Figure 1-32 How to supply power to the Plixus AE-R

PLIXUS MME

The Plixus MME has an internal power supply. To supply power to the units using the Plixus MME put the cables in the correct order:

1. Blue cable = 0 V
2. Green / yellow cable= earth
3. Brown cable = 48 VDC

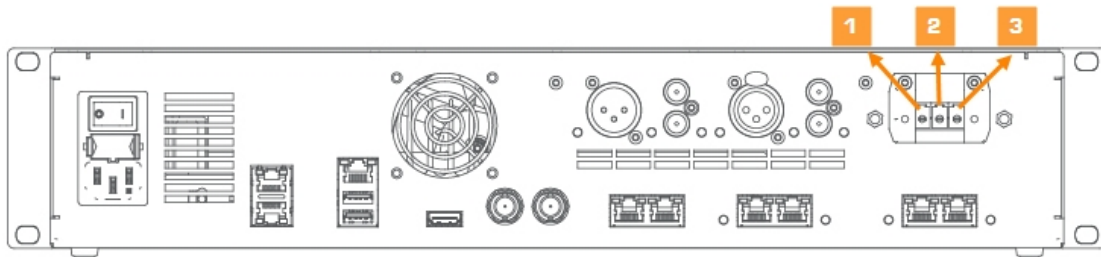

Figure 1-33 Power connection of Plixus MME

You can supply power the units over Ethernet. Each **conference ports** can supply a **maximum of 100 W**.

INSTALL CABLES

Use CAT 5e cables to connect Plixus AE-R or MME to the delegate and chairmen units, and to connect the different units in a branch / loop. For more information on cable details, see "Cable requirements" on page 54.

Televic has standard pre-made cables available in different lengths:

- > YPC/2 2 m
- > YPC/5 5 m
- > YPC/10 10 m
- > YPC/20 20 m

The voltage level at the output of the central unit is 48 V. A voltage drop is caused by the length of the cable and the number of units. The last unit of the branch should receive at least 36 V.

INSTALL MICROPHONES

General Microphone Characteristics

All Plixus compatible units have a screw-lock connector to insert pluggable microphones.

The recommended speaking distance from the mouth to the top of the microphone is between 20 to 40 cm. In order to accommodate the variety of speakers and speaking distances, microphones are available in three different lengths: 30 cm (D-MIC30SL), 40 cm (D-MIC30SL) and 50 cm (D-MIC50SL).

Technical Microphone Characteristics

Parameter	Specifications
Material	Brass
Color	Matt black, RAL 9011
Transducer principle	Back electret (condenser)
Operating principle	Pressure gradient
Polar pattern	Unidirectional
Nominal conditions	Bias resistor = 1k2 Vdd = 3.3 VDC SPL = 1 Pa
Max SPL @ 1 kHz	110 dB SPL (1% THD+N)
Signal to noise ratio	> 67 dB(A)
Free field sensitivity	9.4 mV/Pa ± 3dB @ 1 kHz or -40.5 dB, 0 dB = 1V/Pa @ 1 KHz
Power supply	3.3 VDC, 0.5 mA
Consumption	0.5 mA (without LED ring) Max. 25 mA (with LED ring)
Connection	Screw lock

Microphone Connector Characteristics

Confidea D-MIC microphones have a 5-pin connector to plug into the different Plixus compatible units. Each pin has a distinct function:

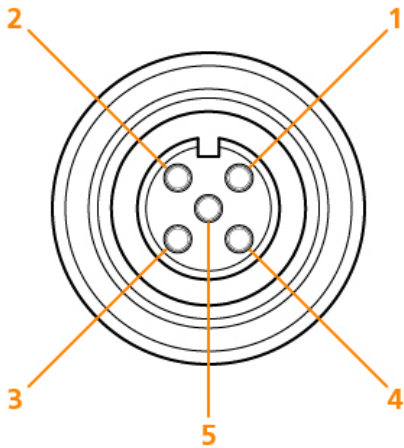

Figure 1-34 Microphone connection

1. Pin 1: Microphone GND
2. Pin 2: Microphone signal
3. Pin 3: not used
4. Pin 4: LED +
5. Pin 5: LED -

Microphone Operation Modes

The microphone contains the following elements:

- > **Indicator ring:** shows the status of the microphone
- > **Union nut:** attaches the removable microphone to the unit
- > **Microphone plug:** connects the microphone to the unit

The color of the microphone indicator ring shows the **status** of the microphone:

Color	Status
Red (continuous)	Microphone is active
Red (blinking)	Last minute of speech time (if set via software) Speech Request (if set via software)
Green (continuous)	Microphone is initialized
Green (blinking)	Microphone request

INSTALL DELEGATE UNITS

Keep at least one meter between two consecutive units to prevent howling effects.

Connect Plixus Units

For all system cable connections use CAT 5e FTP cables with an RJ-45 shielded connector. Plixus units have an automatic port sensing feature. This means that it doesn't matter which port is used, the units automatically detect whether it is an input or output.

Each unit has two conference ports, below you can find a list with all Plixus compatible units and the location of their conference ports.

Unit type	Conference port location
Confidea T	Bottom side of unit
Confidea F	Built-in part of unit, location may vary depending on the type of unit.
uniCOS	Built-in part of unit
Interpreter Desk	Back side of unit

Connect To Plixus Engine

After connecting the different Plixus units to each other, connect the branch of units to one of the conference network ports of the Plixus AE-R, MME or a network extender.

- › The Plixus AE-R and MME have four conference network ports.
- › **General rule:** 80 units can be supported directly by the central unit. However this depends on type on units , cable sections and length. To calculate the exact amount with the Plixus power calculator tool.
- › The central unit can deliver 400 W for external loads (for the Plixus AE-R this is 200 W, which you can increase to 400 W with an additional external power supply)
- › The cable length to the first unit should not exceed 100 m.
- › The cable length between the units should not exceed 100 m.

INSTALL CONFIDEA G3

Within Plixus it is possible to connect the engine to a Confidea G3 wireless system. When connected, Plixus will treat the units the same way as all other wired units.

Connect Wireless Conference Access Point (WCAP) To Plixus Network

Use the conference ports on the WCAP to connect to the Plixus engine or a network extender. In some cases you want to have multiple WCAPs available (see "Combine Plixus with Confidea G3" on page 56 for more information). You can daisy chain multiple WCAPs in one branch. We suggest not to put more than eight WCAPs on one branch.

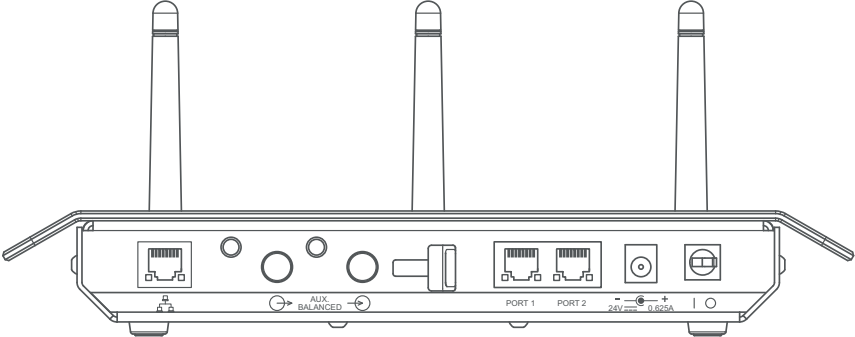



Figure 1-35 Back view with conference ports on Confidea G3 WCAP

To supply power to the WCAP you can use its external power supply, but you can also use the power supplied by the engine or network extender with power over Ethernet.

 When your setup contains multiple WCAPs, then these should use a different frequency to allow successful initialization.

INTRODUCTION

Plixus features three different software components:

- › Default web server: the web server you see when you first use the system. Contains basic functionalities that are also covered by Plixus Core.
- › **Plixus Core:** is a bundle of conference logic that runs on the Plixus system and allows to run the conference system without a dedicated computer, but with the use of a web server.
- › **CoCon:** is the complete software suite for conference management.

Plixus Core

From CRP 5.1 onwards, the Plixus system provides the possibility to use Plixus Core. Below you can find a list containing all functionality that is available in Plixus Core. This guide will discuss all these features together with how to configure and use them.

- › Initialization of the units, creation of booths
- › Discussion parameters for microphone modes
- › Configuration of different audio settings such as the dynamics processor, auto gain reduction, auxiliary input and output levels
- › Selection of basic audio routing presets (normal audio routing, N-1, external equalizer)
- › Interpretation configuration up to 11 languages and possibility to send language channels to Dante
- › Operator page to control microphones
- › Recording of one or more channels
- › Regional settings such as date and time format
- › Manage network settings
- › Camera protocols
- › API

Plixus Core Versus CoCon

There are some differences between Plixus Core and the CoCon software. You cannot configure all parameters of each feature in Plixus Core, for this you need a CoCon license. For a detailed description of

the difference between the two, see the table below.

	Plixus Core	CoCon 5.2
Start/Stop initialization	Yes	Yes
Retrieve initialization	Yes	Yes
Creation of synoptics	No	Yes
Support for multiple synoptics	No	Yes
Configuration of interpreter booths	Yes	Yes
Changing seat priority (delegate – chairman)	Yes	Yes
Default microphone mode	No default, the last configured mode is used	Yes
Meeting management	No	Yes
Delegate management (delegate names, groups)	No	Yes
Agenda creation	No	Yes
Voting management	No	Yes
Speech timers	No	Yes
Services (uniCOS)	No	Yes
Messaging (uniCOS)	No	Yes
Badges and authentication	No	Yes
Operator control	Yes, limited through web server Operator page	Yes, full Operator control available
Activation of microphones	Yes	Yes
All microphone modes supported	Yes	Yes
Meeting statistics	No	Yes
Import/export of meeting data	No	Yes
Voting control	No	Yes
Signage	No	Yes

	Plixus Core	CoCon 5.2
Basic interpretation	Yes, up to 11 language configurable from web server in Standalone	Yes
Advanced interpretation (with all ISO 90107 features)	No	Yes
Three basic audio configuration (normal, distance conferencing, external equalizer)	Yes, configurable from web server	Yes, included in Plixus Core web server
Advanced audio configuration	No, but once created with CoCon, selectable from web server	Yes, full audio routing matrix available with Audio application
Camera protocol	Yes, sent from Plixus engine	Yes, sent from Room Server

CONFIGURE IP SETTINGS

Before you start using the Plexus web server you need to configure your local IP settings to be able to access the web server. Follow the procedure below to configure this.

To be able to access the web server your computer needs an IP address and subnet mask that can access the IP address of the engine. The **default IP address** of the engine is **192.168.0.100**, which means the computer should have an IP address that is within the same subnet, like 192.168.0.200. The subnet mask must be the same for all equipment on the network, being 255.255.255.0.

Change IP Settings In Windows

1. Go to **Control panel**.
2. Click **Network and Internet** and then **Network and sharing center**.

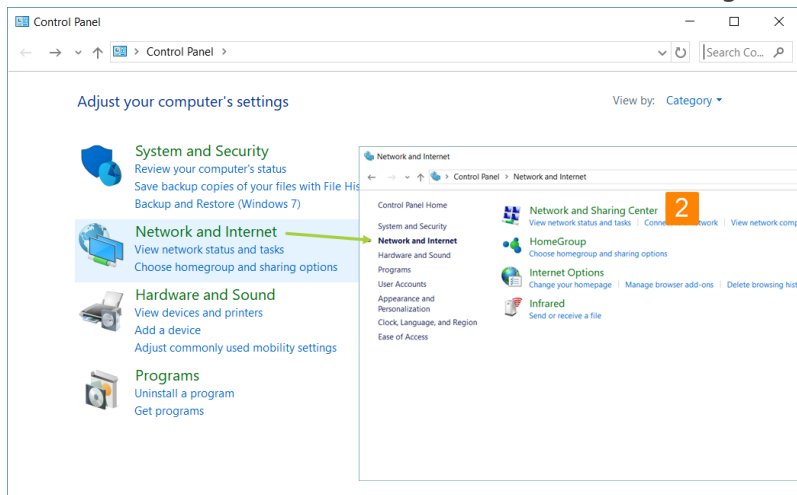

3. Click **Change adapter settings** in the menu on the left.

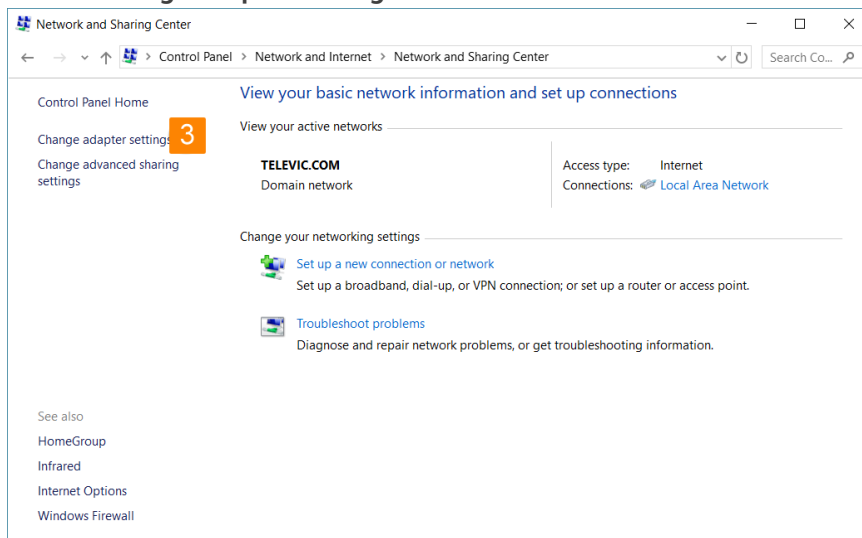

4. Right-click the **Local Area Connection** and select **Properties**.

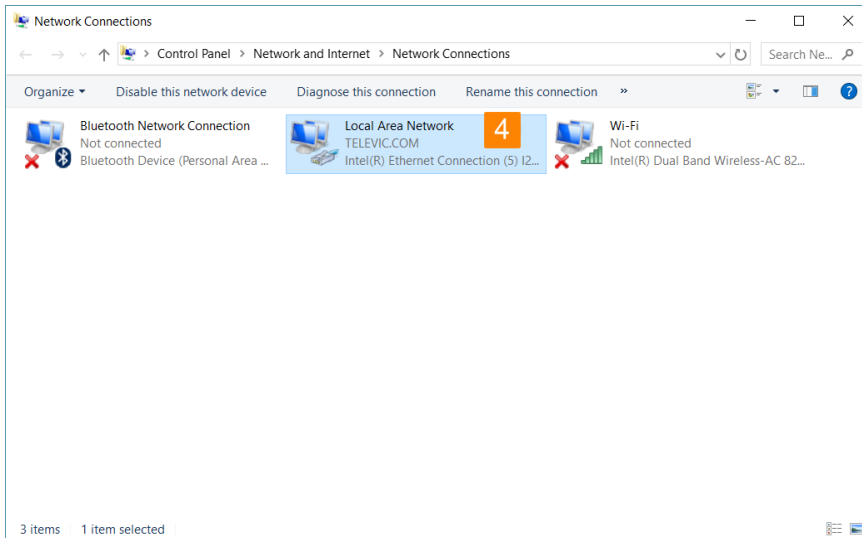

5. Select **Internet Protocol Version 4 (TCP/IPv4)** and click **Properties**.

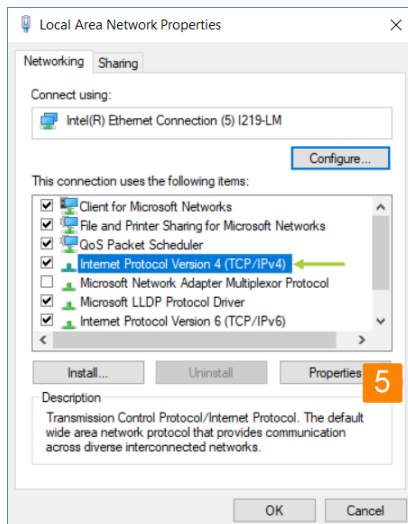

6. To assign a fixed IP address to your computer, click **Advanced**.

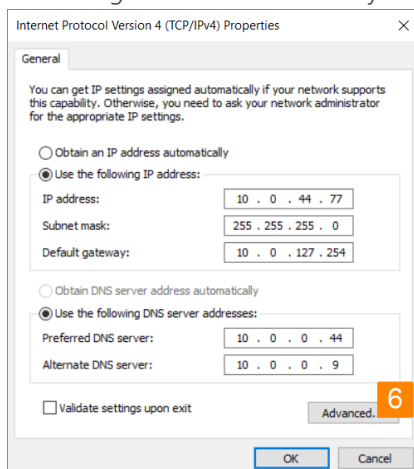

7. Click **Add** in the IP address pane.
8. Enter an IP address in the range of the engine, for example 192.168.0.26. Fill in 255.255.255.0 as subnet mask.
9. Click **OK**. You are now ready to access the engine.

Change IP Settings In MacOS

1. Go to the **Apple Menu** and select **System Preferences**.



2. Select **Network** from the menu.

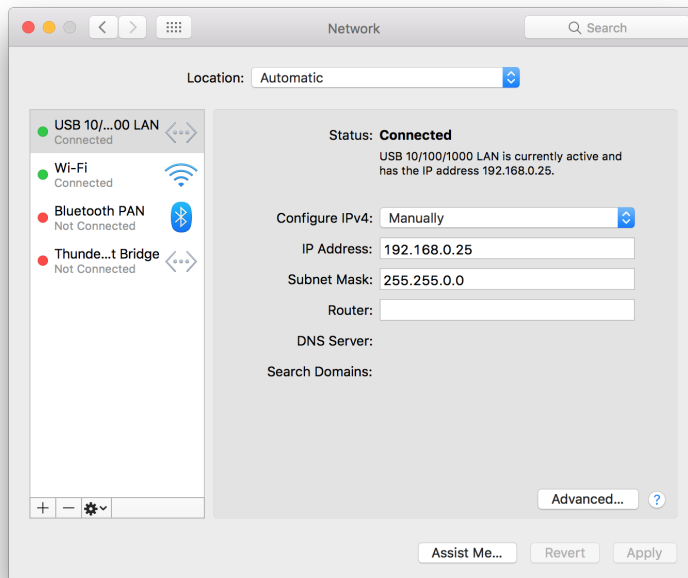

3. Click the **Advanced** button.

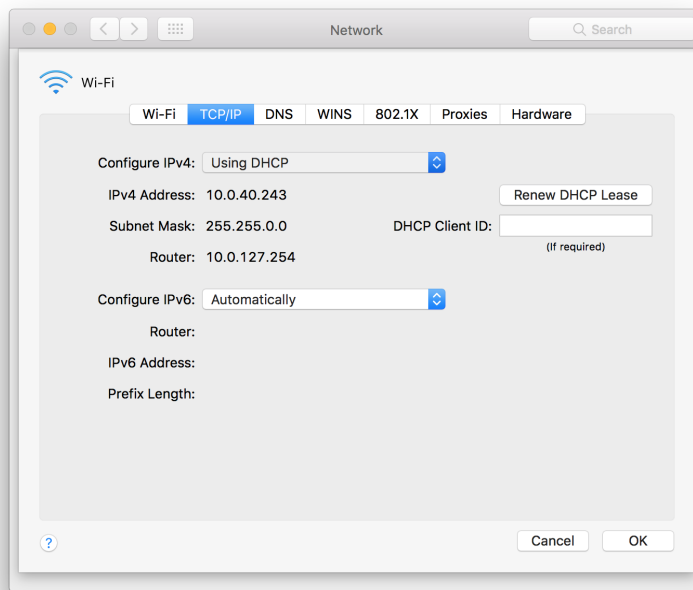

4. Select **TCP/IP** in the menu on top.

5. Change **Configure IPv4** to **Manually**.

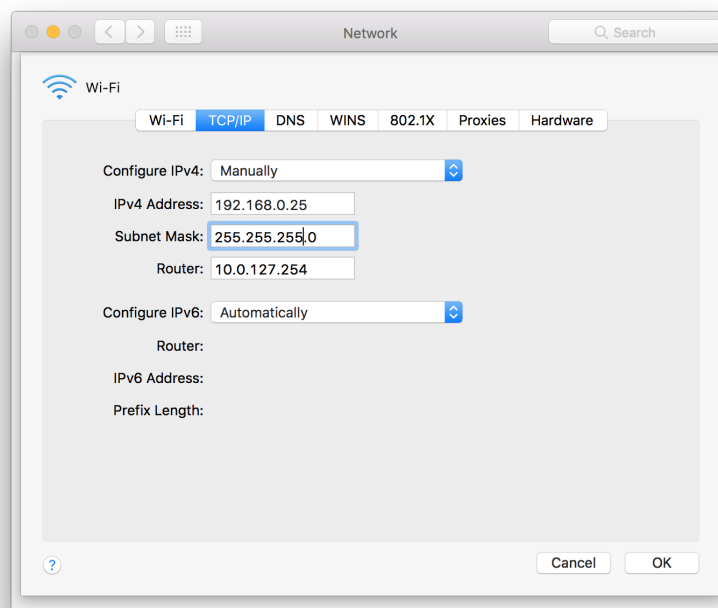

6. Enter an IP address in the range of the engine, for example 192.168.0.25. Fill in 255.255.255.0 as subnet mask.

7. Click **OK**.

GETTING STARTED WITH PLIXUS CORE

Activate Plexus Core

To access the web server of the Plexus system, enter the IP address of the Plexus engine in your browser. The default IP address of the Plexus engine is 192.168.0.100 with subnet mask 255.255.255.0.

The first time you will need to activate Plexus Core. Go to **Settings**, select **Info** and click **Start Plexus Core**.

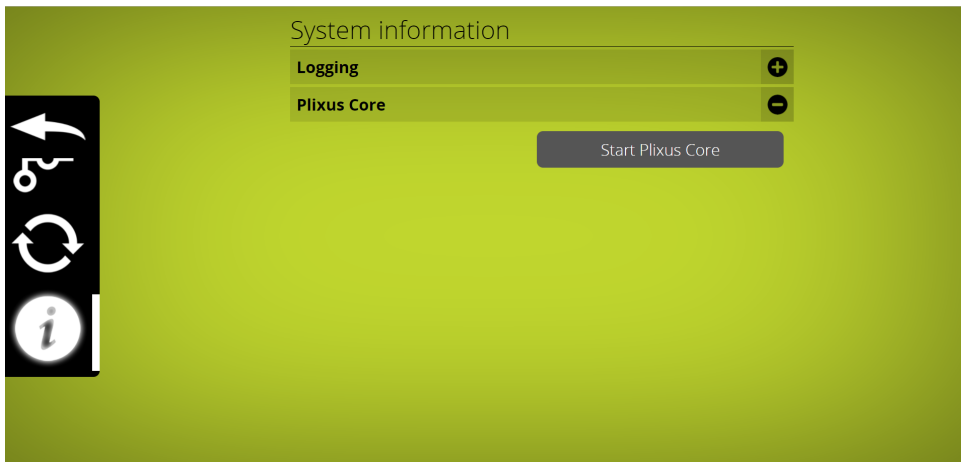

Figure 1-36 Start Plexus Core from the default web server



If the web server does not refresh automatically, you can refresh it manually. Loading the new web server may take up to 1 minute, the very first time.

Explore Plexus Core

The layout of the web server was designed to be intuitive and easy to use. All pages have a similar layout which eases configuration. The general layout consists out of two parts:















- > **The header element (1):** this part contains the name of the product together with the title of the page. From here you can also access the main menu by clicking the menu icon .
- > **The body element (2):** on this part of the page you can view and configure all settings. The content will change depending on the menu item you select.



Figure 1-37 General layout of the web server

When you want to configure a certain setting, you simply select the correct sub menu from the main menu (). The following sub menus are available:

Icon	Sub menu	Description
	Home	Return to the home screen where you see the most important features and their configuration.
	Initialization	Define and configure units present in the Plixus network.
	Discussion options	Configure discussion options such as microphone to define how to activate a microphone.
	Audio	Configuration of different audio options such as dynamic processing and auto gain reduction.
	Audio routing	Configure the audio routing and the auxiliary input and output levels.
	Interpretation	Configuration of the interpretation channels.
	Operator	Control all microphones in a meeting.
	Recording	Options to record the meeting.
	Regional settings	Change regional settings.

Icon	Sub menu	Description
	Network	Configure network settings and set camera protocol.
	Users	Change user name and password.
	System info	Contains system information such as license information, system logging, (de)activation of Plixus Core and configuration management.
	Update versions	Overview of all firmware and software version together with the option to update to another version.

THE HOME PAGE

This is the default landing page of the web server and it shows general together with crucial information about the current state of your conference system. Click the feature name to go to the dedicated page to configure the setting.

On the left side you can see the following information:

- > General volume
- > Microphone mode
- > Number of active units
- > Number of faulty units
- > Number of connected but uninitialized units



Faulty units, means that there are units missing, that are normally in the initialization list. If this is the case, this is indicated in red. A reason could be that they are not booted correctly or that they are physically disconnected from the Plixus network.

On the right side you see the following items:

- > IP address of the system
- > MAC address of the Plixus engine
- > Connection status with CoCon Room Server
- > Connection Status with Plixus Core



By default it is not possible to disconnect from Plixus Core, however when Plixus Core crashes home page will show **Plixus Core Not connected**. Click Restart to **restart** Plixus Core.

INITIALIZATION

Introduction

The Plixus system always works with seats. A seat is a conceptual name for a unit or a group of units which are combined on that seat. By default this is a one-to-one mapping, so every unit has one seat. However, there can be more advanced cases where units are manually combined on a seat. During initialization you can assign units to seats.

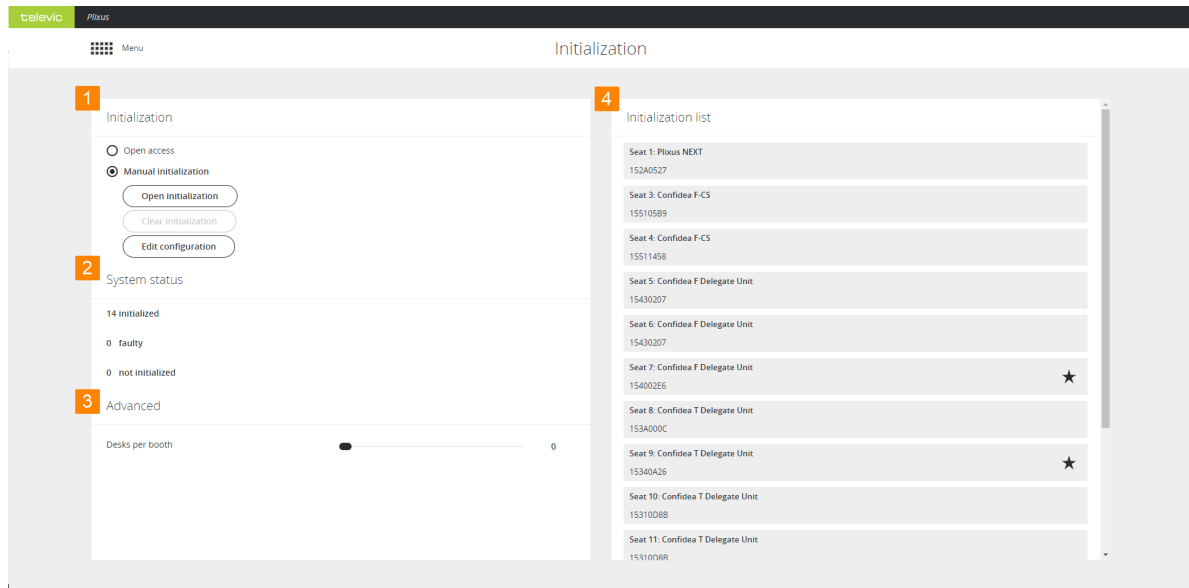

Figure 1-38 Initialization page

1. In **Initialization** on the left side of the page you select the mode of initialization.
2. **System status** shows the status of all units, you can see the amount of **initialized**, **faulty** and **not initialized** units. Faulty units are units that were initialized, but are now missing. Not initialized units are connected, but not yet initialized.
3. In the **Advanced** settings you can define the maximum number of desk per booth (for interpretation).
4. The **Initialization list** on the right side shows all uninitialized units, per unit you can see the following information:
 - a. Seat number: position of the unit in the meeting room
 - b. Unit type
 - c. Chairman capabilities: can unit acts as chairman, indicated by star icon.

- d. Serial number: of the unit
- e. Booths: all available booths together with the amount of desk per booth and the units.

How To Initialize Units



There are two initialization modes possible: **Open access** and **Manual initialization**.

OPEN ACCESS

- › This is the default mode. The main purpose of this mode is to provide a quick way to set up and/or test the system.
- › Seats are automatically assigned to the units after startup. Assigning seats is done according to the cabling topology of the units. This means that seat one is assigned to the first unit at port one of the Plixus engine.
- › For network extenders connected to the Plixus port, seats will also start with port one of the network extender. The system automatically discovers the redundant loops.
- › Interpreter desks are automatically divided into booths according to the setting **Number of desk per booth**, under **Advanced** settings.
- › Upon restart of the Plixus engine (or Plixus Core) in **Open Access**, the network will be rescanned and seats and desks will be assigned accordingly.
- › In Open Access mode, it is not possible to edit the configuration of the units (seat number or delegate/chairman priority), nor change the configuration of the booths.
- › When changing from **Open access** to **Manual Initialization**, the initialization and seat order is preserved.

MANUAL INITIALIZATION



- › Use **Manual initialization** when you want to define which unit is assigned to which seat number. This can be important when using camera tracking as well as CoCon seat allocation. Manual initialization allows you to edit the configuration in terms of chairman / delegate priority and booth configuration after initial configuration.
- › Click **Open initialization** to start the initialization phase. This causes uninitialized microphones to blink red and initialized microphones to blink green. Add units to the initialization list by pressing the microphone button. During manual initialization you can perform the following actions on the units:

- > : click to **swap unit**. When a unit is faulty, it will be greyed out in the web server. Click the icon and enter the serial number of the new unit. Click the checkmark icon  to confirm. Note that you can only replace units with units of the same type.
- > **#**: click to **modify** the **unit number**. If you do this during the initialization, the next assigned unit number will be the highest unit number + 1.
- > : click to **remove** individual units during initialization. After removal the microphone LED will blink red again.



It might take several seconds before the microphones start to blink when you click **Open initialization**.

You can only manual initialize units with a microphone button. Units without this button (e.g. Confidea channel selector) are automatically assigned to a seat.

- > Click **Stop initialization** to finish and the seats are automatically assigned to the units. Stopping initialization might take a while, up to one moment depending on the number of units. The seat number will automatically map to the unit number and the Lingua ID's to desks in booths according to the setting **Desk per booth**.
- > Click **Edit configuration** to change the following settings
 - > **Chairman priority**: click the start icon ( or ) to change priority of the unit. A unit that is hardware-wise not a chairman unit can receive chairman properties. This then becomes a VIP unit.
 - > **Booth configuration**: click the booth icon  to change the booth configuration. Create new booths or group desks by changing booth and desk number.



Do not reload the page when editing the configuration.

Do not change properties during meetings, because this can disturb your meeting.

You can also use CoCon to configure different settings such as the priority of the unit.

- > Click **Clear initialization** to clear the initialization list, as consequence all units will start to blink red. It is only possible to clear initialization when the initialization is open and units are not faulty. Confirm to finish clearing the initialization.

DISCUSSION OPTIONS

In this chapter you will find all information to configure the most important settings of your meeting. These settings are the number of open microphones, the microphone mode and the color of the microphone LED.

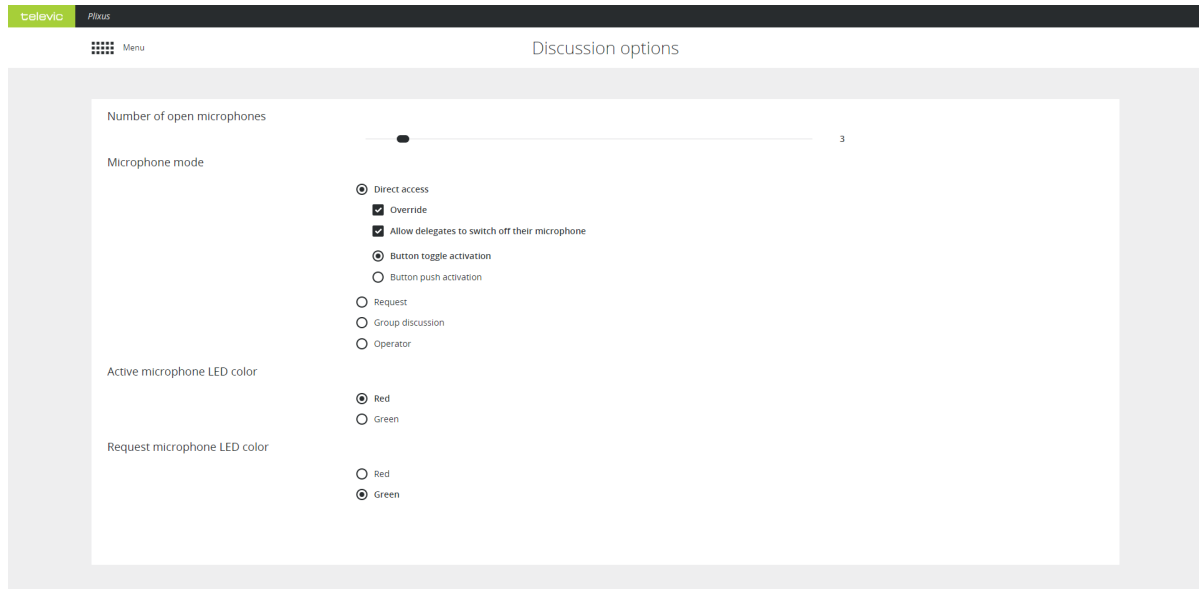

Number Of Open Microphones

You can set the number of open microphones be between 1 and 25. This does not include the chairman microphones. You can activate up to eight additional chairman microphones on top of the 25 delegate microphones.

Microphone Mode

Different microphone modes are available and depending on the mode, you can configure additional settings.

DIRECT ACCESS

With direct access delegates can activate their own microphone by pushing the microphone button. The following additional settings are available:

Parameter	Description
Override	<p>> Not-selected: microphone will not become active when the maximum number of open microphones is reached and you press the microphone button. Another active microphone must switch off first. Deactivation is possible by the delegate, via the operator page, through the chairman using the API or CoCon.</p> <p>> Selected: when the maximum number of open microphones is reached, the first activated microphone will switch off when a delegate presses its microphone button.</p>
Allow delegates to switch off their microphone	With this option you ensure delegates cannot switch off their own microphone. Only the operator or chairman can do this.
Button toggle activation	Press the microphone button once to activate the microphone.
Button request activation	Keep button pressed to activate to microphone. When you release the button, the microphone will switch off.

REQUEST

In request mode you do not automatically get the floor when you activate your microphone. First you have to request the floor. The chairman then assigns the floor to a speaker using the next-in-line button (or using the operator page, CoCon or the API). Which delegate may speak first is defined by the first-in-first-out principle. The chairman units (or VIP units) can always speak immediately and do not have to request the floor.

For request mode additional settings can be configured:

Parameter	Description
Allow delegates to cancel their request	Select this option to allow user to cancel their request to speak by pressing the microphone button.
Allow delegates to switch off their microphone	Select to allow user to switch off their microphone by pressing the microphone button. If not selected the microphone will only switch off when another events stops the microphone for example by using the operator page.
Enable reply	Select to enable the reply functionality. With this function you can reply to a certain speaker which will put you in different request list that has priority over the default request list. Define which button to use for the reply function (Reply, Prior, Next).

VOX

Voice activation (VoX) is a mode where the microphone button is not used. The microphone becomes active when it detects sound above a certain threshold. You can configure **Voice activation** in the **Group discussion** mode. The following settings can be configured:

Parameter	Description
Threshold	The system will monitor the ambient sound level and will activate the microphone when it is above the configured threshold value.
Hold time	Determines the number of seconds the microphone stays active after detection of the last sound above threshold.

GROUP MODE

Group mode is a semi-automatic mode for standalone conferences where less protocol has to be followed and no operator is available. Pressing the microphone button activates the microphone unless the maximum amount of open microphones is reached. In this case the microphone will go into request mode. When another microphone becomes inactive, the first unit in the request list will become active.

This mode has 3 activation types: toggle, push to talk and vox.

Mode	Description
Toggle	Press microphone button once to activate microphone.
Push to talk	Keep microphone button pressed to activate microphone.
Voice activation	Microphone becomes active when it detects sound above a defined threshold. For more information see "VoX" .

OPERATOR

With the operator mode delegates **cannot activate** their own microphone. Only a command from CoCon, the operator page or the API can activate these delegate microphones. Delegates can deactivate their microphone by pressing the microphone button. **Chairman** can always activate microphones and use the **priority button** if he wants to switch off the delegate microphones.

Microphone LED

Change the LED color of an active microphone or a microphone in request. By default the LED of an active microphone is red and for a microphone in request green.

RECORDING

With the Plixus AE-R you have the option to record meetings. You can start recording by pressing the button on the engine or by using Plixus Core. Save the recording on the integrated hard drive or to an external USB device.

 Recording is only possible on an external USB device with NTFS format.

Record Using The Record Button

Press the record button on the front display of the engine to start recording. A LED light next to the button indicates that the engine is recording. Press the button again to stop the recording.

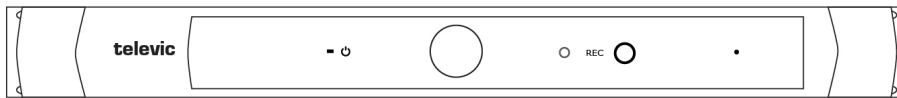

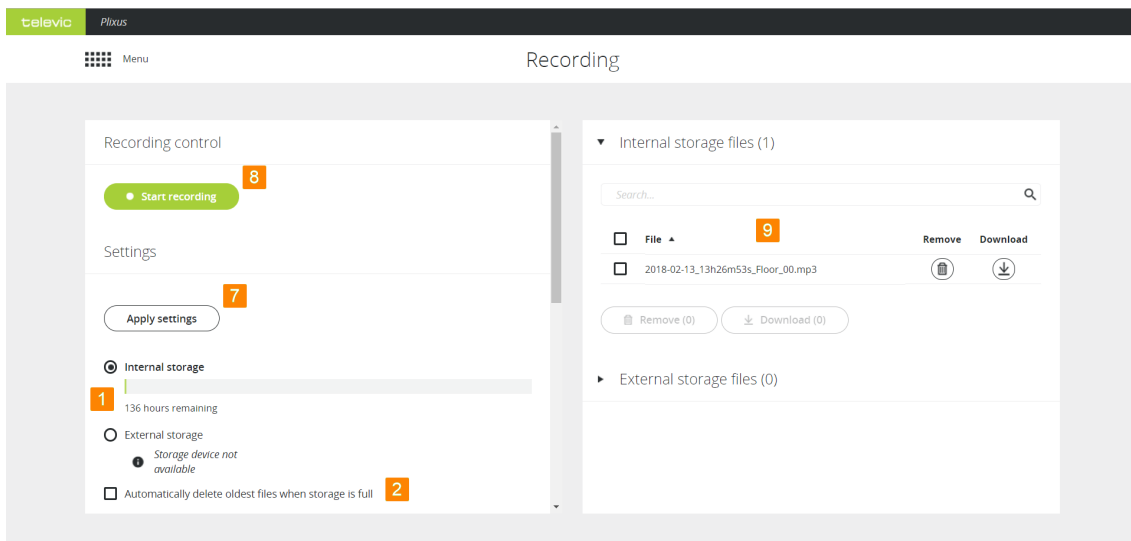
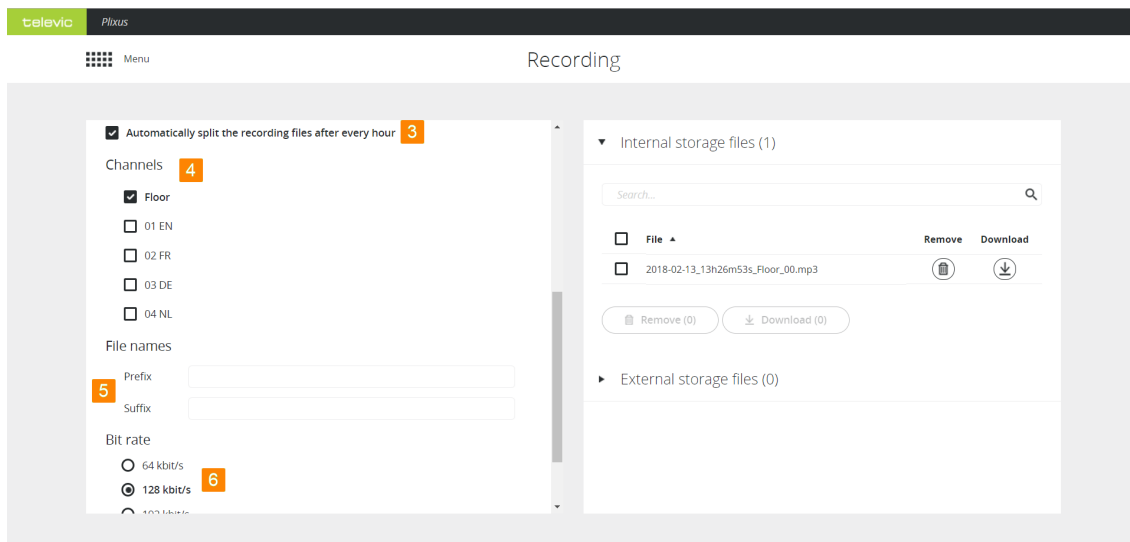

Figure 1-39 Record button on Plixus AE-R engine

Record Using Plixus Core

To record your conference using Plixus go to the main menu  and select Recording .















1. Select where to store the recording. Select **Internal storage** to store the recording on the engine locally or select **External storage** to store the files to an external USB device connected to the engine. For the internal storage you can see the remaining disk space, this depends on the audio quality you selected.
2. Select this option to delete the oldest files on the engine or external USB device when there is no more disk space.
3. This option splits up recordings into different files when the recording time is larger than one hour.
4. Select the channels you want to record. Per channel a different recording will be created.
5. Define a prefix and/or suffix to be automatically added to your recording file name. By default the date and time are added to the file name.
6. Select the quality of the recording. By default 128 kbit/s is selected which renders medium quality audio files.
7. Click **Apply settings** to save the configuration.
8. Click **Start recording** to start and click **Stop recording** to finish your recording.

Manage Recorded Files

▼ Internal storage files (5) **1**



Search... **2** 

<input type="checkbox"/> File ▲	Remove	Download
4 <input type="checkbox"/> 2018-02-13_13h26m53s_Floor_00.mp3	 3	
<input type="checkbox"/> TCS_2018-02-13_14h37m28s_Floor_00.mp3		
<input type="checkbox"/> TCS_2018-02-13_14h37m56s_Floor_2018_00.mp3		
<input type="checkbox"/> TCS_2018-02-14_11h36m12s_01-EN_2018_00.mp3		
<input type="checkbox"/> TCS_2018-02-14_11h36m12s_Floor_2018_00.mp3		

5

▶ External storage files (0)

Figure 1-40 How do download and remove your recorded files

1. Go to the location where your files were recorded: on the engine itself or on an external USB device.
2. You can search for specific files using the **Search** bar.
3. Download  or remove  single files using the buttons next to the file.
4. Select multiple files using the check boxes next to the file names.
5. Download or remove the selected file by clicking on the **Download** or **Remove** button.

AUDIO SETTINGS

On the Audio page you can configure all general audio settings for the Plixus system.

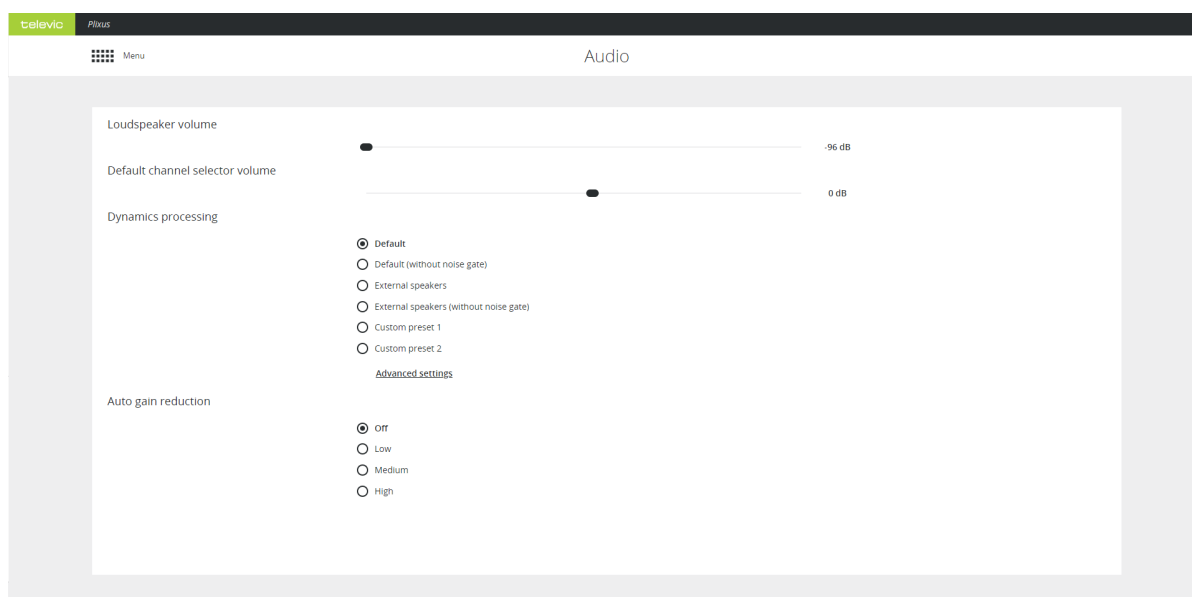

General Volume

This sets the volume for the loudspeakers in the room. The value can range from -96dB to +6dB. You can also change the volume by turning the control dial of the MME or volume dial of the AE-R.

Dynamics Processing

The dynamics processor settings are global settings that are applied to every microphone unit individually. These settings determine the dynamic range of the audio input.

There are four default presets available for the user, for a detailed description of these presets see the table below. Click **Advanced settings** to see these presets and edit them. However, you cannot overwrite predefined options, you can only save changes as Custom preset 1 or 2.

Preset	Description
Default	This preset has been optimized for medium-size conference rooms.
Default (without noise gate)	Removes the noise gate, use when the noise in the room is limited.
External speakers	Shifts the knee-point of the compressor stage to a higher input value resulting in less chance of feedback when external speakers are used.

Preset	Description
External speakers (without noise gate)	Same settings as external speakers, but without the noise gate.

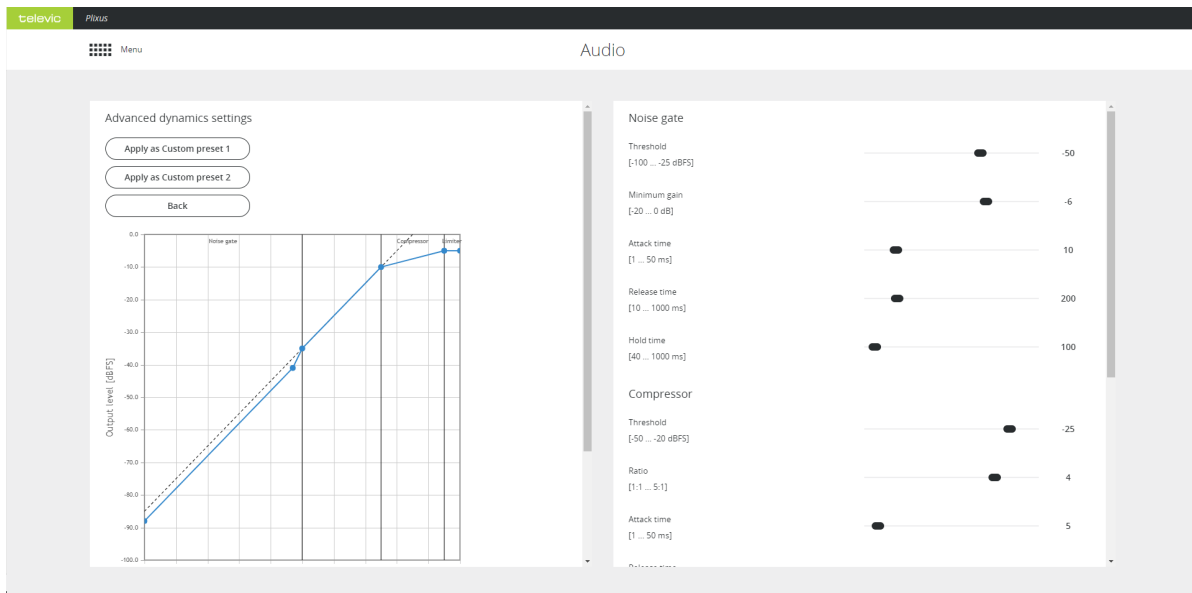
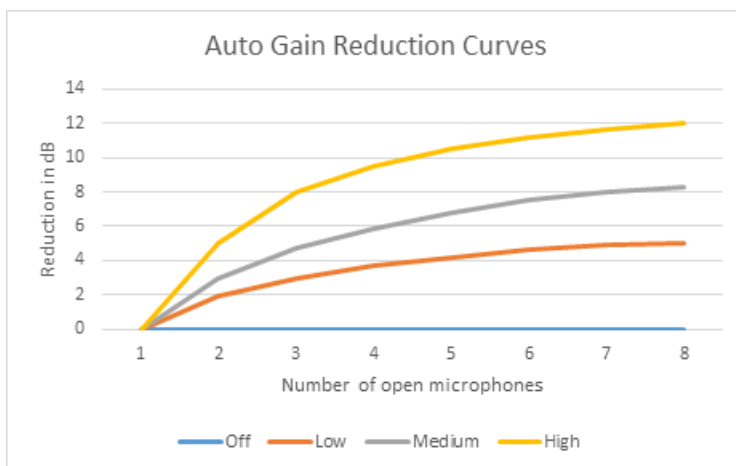

Figure 1-41 Figure 3 13 - Audio - Advanced dynamics settings

Auto Gain Reduction

Auto gain reduction reduces the amount of gain in signal in function of the amount of open microphones. As the number of open microphones causes the noise to go up, a gain reduction can increase the intelligibility. There are four presets available with different gain curves:



In rooms where the acoustics are very good, the auto gain reduction may be turned off. In smaller rooms or rooms where external speakers are quite close to certain microphones, it can be challenging to have enough intelligibility everywhere without feedback. Therefore a medium or high setting may be required.

AUDIO ROUTING

With audio routing you can control all routing configurations and the auxiliary levels. You can configure the following settings:

- › Audio routing configuration
- › Auxiliary input levels
- › Auxiliary output levels and selection of the output channel
- › Automatically route interpretation channels to Dante

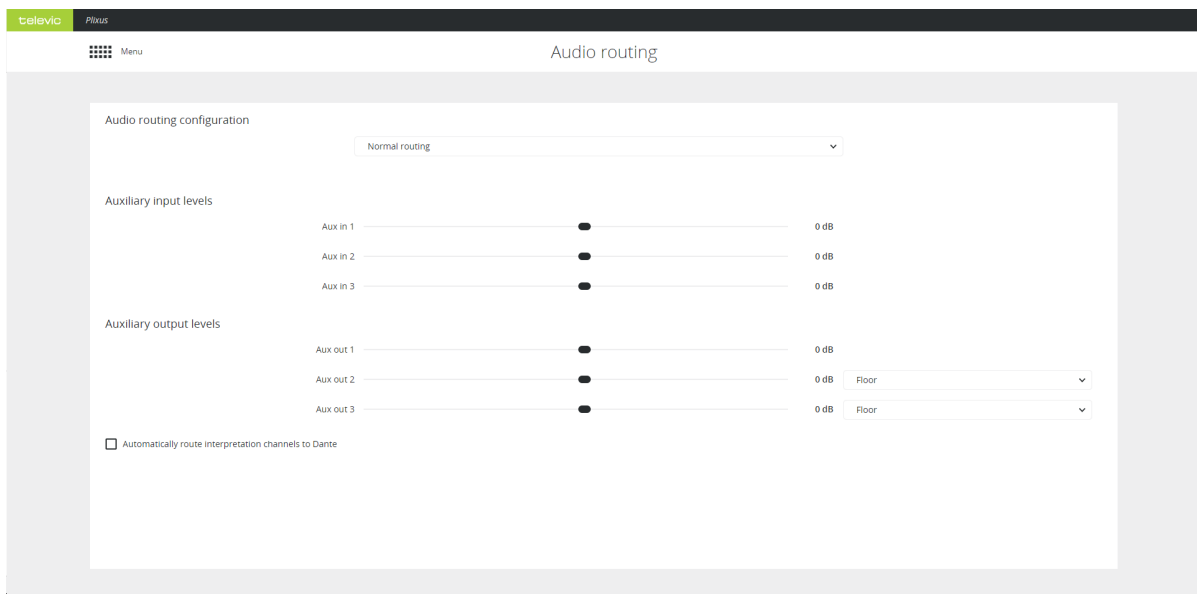

Figure 1-42 Audio routing page

Audio Routing Configuration

By default there are three preconfigured basic routing options. They are explained here with the picture of the CoCon routing matrix:

NORMAL ROUTING

No additional audio routing is done.



DISTANCE CONFERENCING

This adds an external signal, using AUX IN, to the local floor signal and sends the local floor signal, using AUX OUT, to a remote party, for example sitting in a different room.



EXTERNAL EQUALIZER

This option allows you to add an external signal processing equipment or a mixing board.

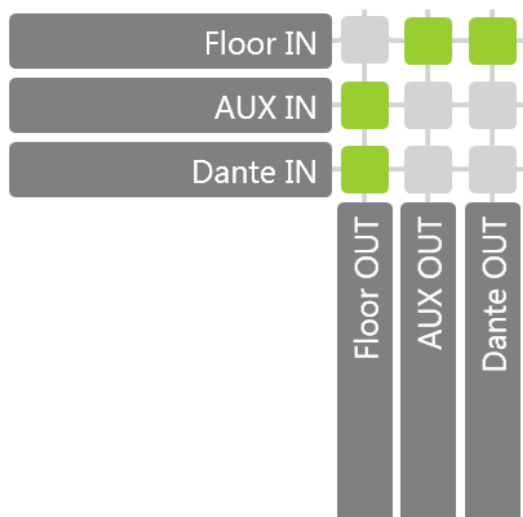

PRESETS FROM COCON AUDIO APPLICATION

You can use the CoCon Audio application to create additional audio routing configurations. After creation these are sent to and saved on the Plixus engine. These are then accessible from the web server, even when CoCon is not running. In contrast to the predefined configurations you can still edit these configurations.

Auxiliary Levels

Auxiliary input levels and output levels are by default referenced on 0 dB. This means there is no amplification or gain reduction. You can adjust the levels manually by using the scroll bar.

Additional Options

When a predefined audio configuration is selected and you use the web server for the interpreter configuration, there two additional functions are available.

- › You can assign an outgoing language channel to Aux 2 and 3. In the drop-down box select the desired outgoing channel. This is only possible when the languages are configured in the web server.
- › All language channels that you configure in the web server can be automatically routed to Dante when you select the checkbox **Automatically route interpretation channels to Dante**.

This means the following for the Dante channels: The floor is always routed to channel number 1. From then on, with the option activated, the other x language channels follow on channel 2 until x+1

INTERPRETATION

On the Interpretation page you configure the languages needed for the meeting. You can add up to eleven channels.

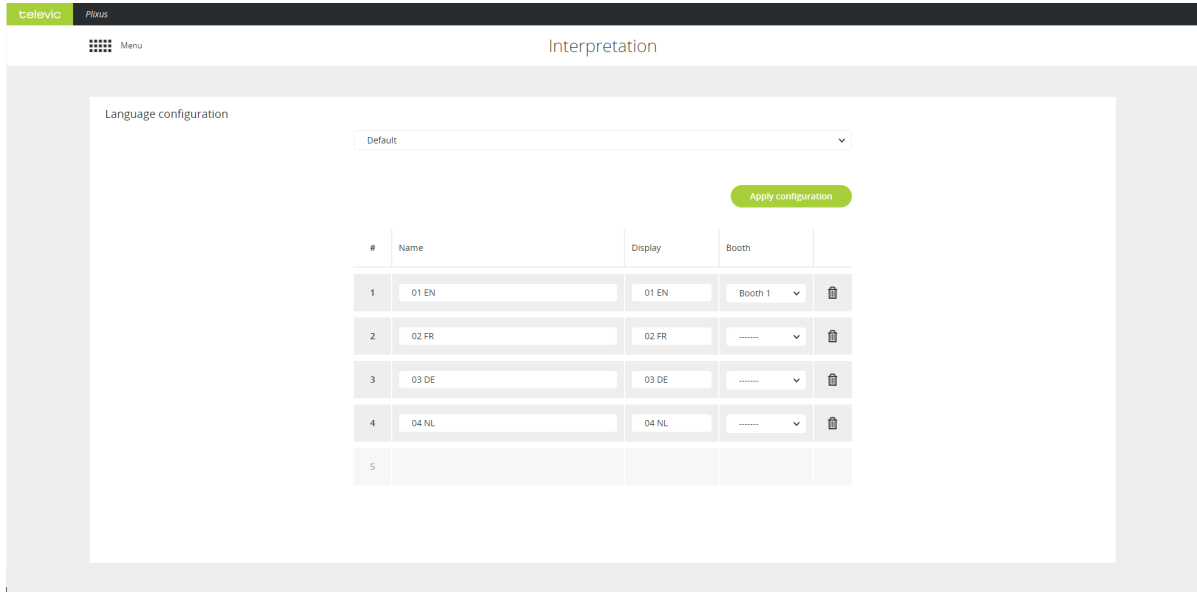



Figure 1-43 Interpretation page

Add New Language

To add a language configuration, click the bottom empty field in the table in the Column Name. You can define the following parameters:

Parameter	Description
Name	Name the language, not used for display but is used for the API output.
Display	Text to display on relays, channels and channel selectors. Limited to seven characters.
Booth	Select one of the initialized booths from the drop down box. The value "-----" represents a virtual booth. This means that you can use the language by selecting it on B/C channels on the Lingua ID.
	Remove the configured language.

Click **Apply configuration** to activate it.

Add Interpretation Configuration From CoCon

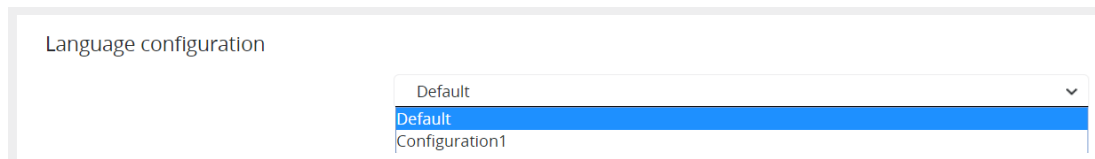

Figure 1-44 How to add language configurations created in CoCon

You can also configure languages in the CoCon Interpretation application. You can find these configurations in the drop down list on top of the page. Select the configuration and click **Apply configuration** to use it. When you open a different configuration, the default configuration will be cleared.

OPERATOR

On the **Operator** page you can control the microphones in the meeting and see how is speaking or requesting to speak. The Operator page consists out of two parts:

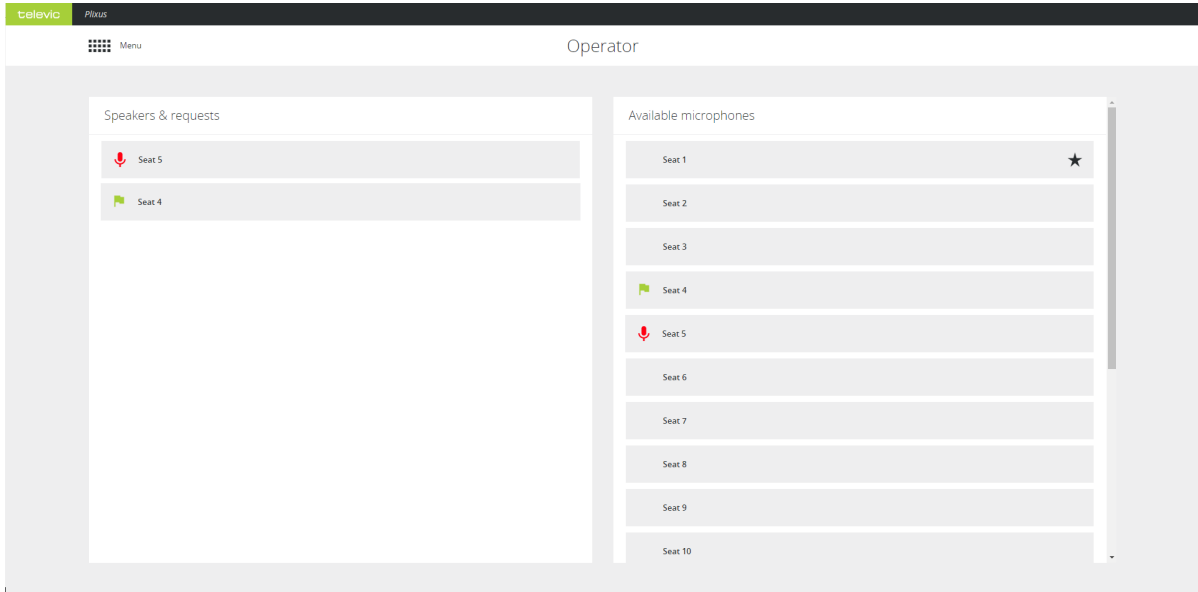





Figure 1-45 The Operator page

List	Description
Speakers & request	Shows all active microphones  , all requests  (only possible with Request microphone mode) and replies  (if configured). Click on an active microphone to switch it off. Click on a microphone in request or reply to turn it on.
Available microphones	This list shows all microphones, sorted on seat number, with an indication of the chairman priority and the active or request microphones. Clicking on a microphone will change the status from either to active or switch off the microphone.

REGIONAL SETTINGS

Go to the **Regional settings** page to change the date and time format.

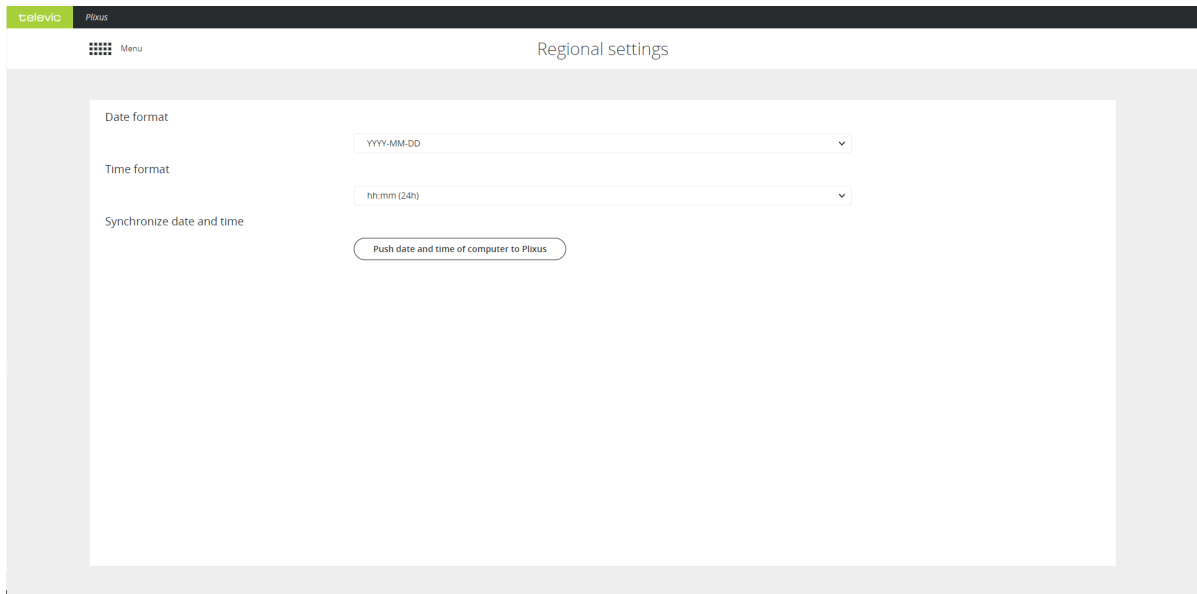

Figure 1-46 *The Regional settings page*

Click **Push date and time of computer to Plixus** to synchronize to time of your Plixus system with that of your computer.

NETWORK SETTINGS

On this page you can adjust the network settings of the Plexus engine and configure the camera protocol which is sent from the Plexus engine to the camera tracking system. Here you are also able to enable the API.

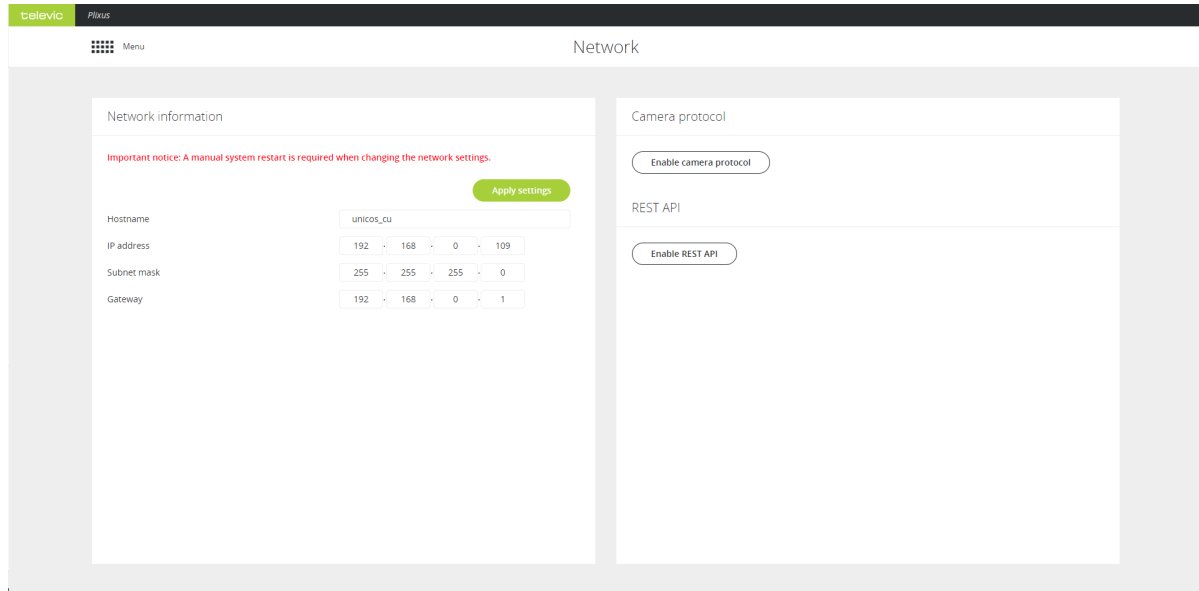

Figure 1-47 Network settings page

Network Information

You can configure the following network parameters:

Parameter	Description
Hostname	Is the name of the Plexus engine.
IP address	The IP address to access the engine, default value is 192.168.0.100 . When you change the IP address, you need to restart the engine to complete the action.
Subnet mask	Default subnet is 255.255.0.0
Gateway	The access point to another network.

Camera Protocol

Camera protocol is disabled by default. When you enable the camera protocol you can configure the following parameters:

Parameter	Description
Camera protocol	Select the protocol you want to use. Three protocols are available: CAM 1, CAM 2 and CAM 5. These are the most commonly used camera protocols that are also provided with CoCon. For more information on camera protocols see the appendix.
Network protocol	Both TCP/IP and UDP are provided.
Port	This is the port on the client where the camera protocol is either sent to (UDP) or where the third party client has to listen to on the Plixus engine (TCP)
IP address	When you select UDP you need to specify the IP address of the destination (third-party).

REST API

The Plixus Core API provides a subset of commands that are available on the CoCon API. The Plixus Core API has the same communication protocol and command structure as the CoCon API which allows third-party programmers to simply change the IP address from the CoCon Room Server PC to the Plixus Engine. By default the API is disabled.

Default TCP port for API connection is port 8890



The following TCP ports are reserved for the Plixus system, do **NOT** use for camera control: 5011, 5012, 5111, 6011, 6012, 6101, 6111, 6212, 6312 and 8890.

USERS

On the **Users** page you can enable login. When you enable this you will have to define the user name and password. the next time you use the system you will have to give in these credentials.

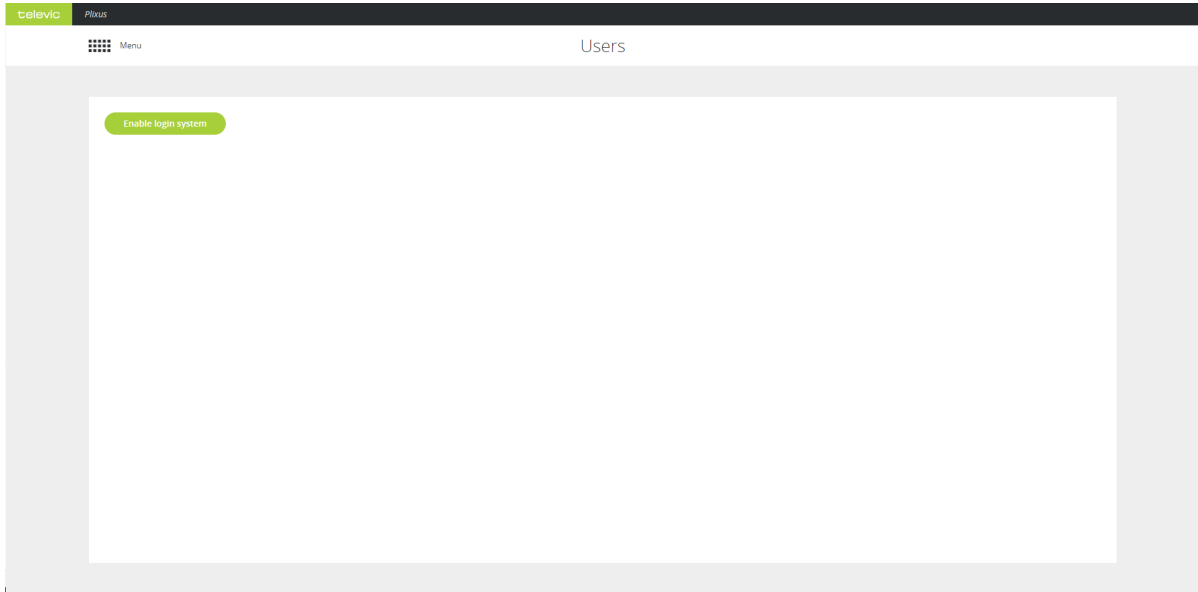

UPDATE VERSIONS

Use the **Update version** page to see the update history of your system and update to a different version.

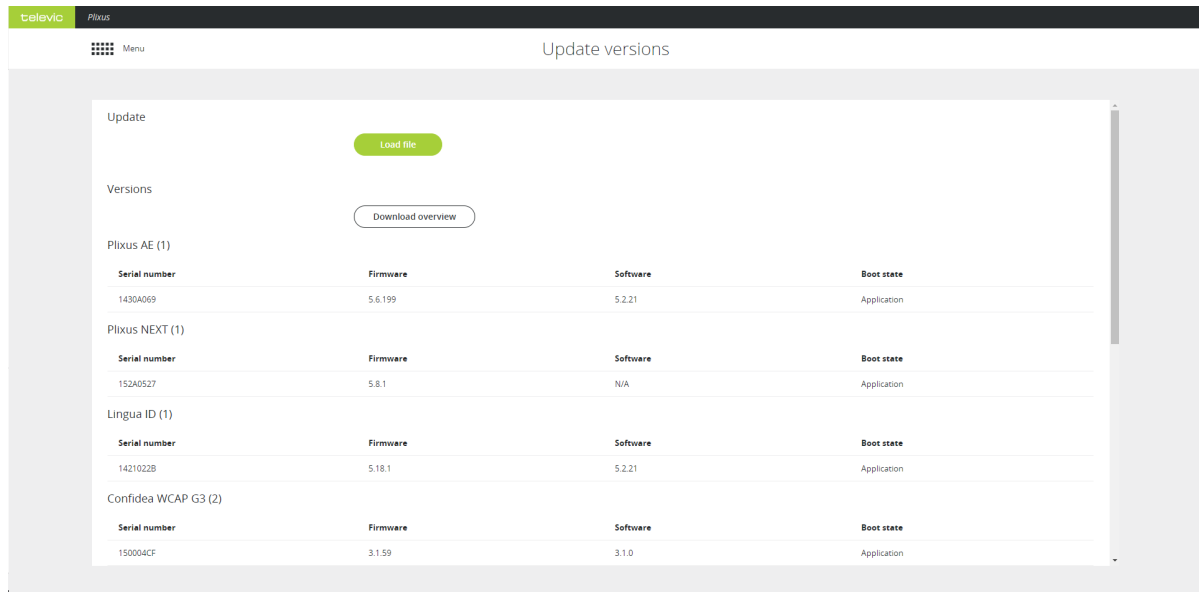

Figure 1-48 The Update page

Update Plixus System

To update the Plixus system, click **Load file**. Open the correct **.tuf** file. Uploading a file can take some time. Do **not refresh** the page during this process.



You can find all Plixus related software updates on the Televic Conference website (<https://www.televic-conference.com/en/plixus-software-updates>).

After upload, click **Start update**. This will start the update process.



Do not switch off, change configurations on the system or refresh the update page while the update is ongoing.

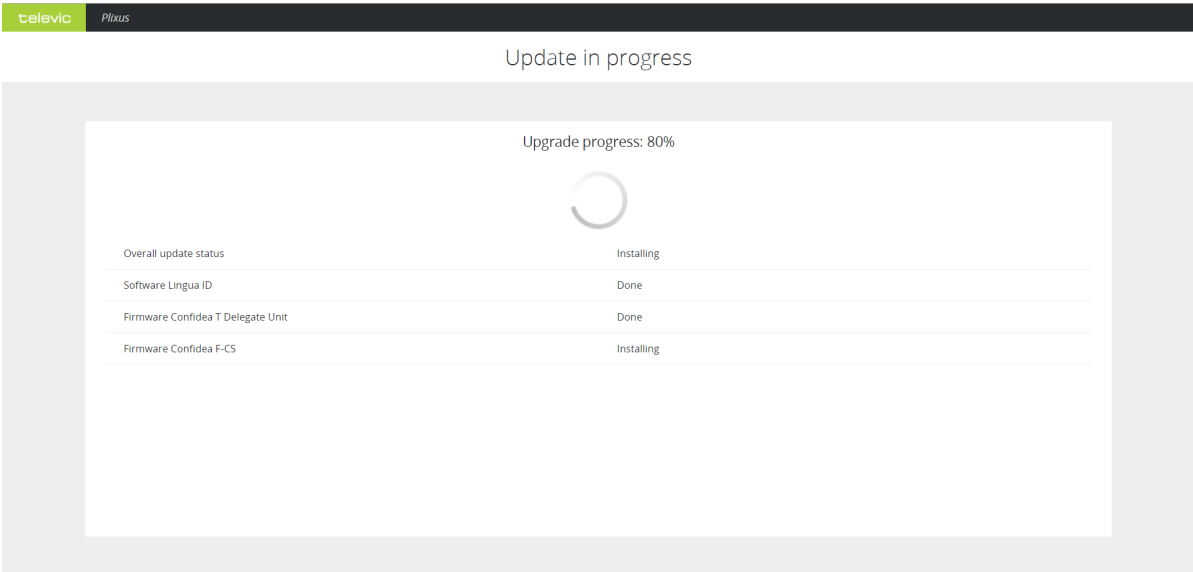

Figure 1-49 Upgrade in process

It can take some time before the update is complete, the duration depends on the number of units and the amount of different units connected to the system.

When the update is complete click **Reboot system** to restart the system. This is required for the update to be successful.

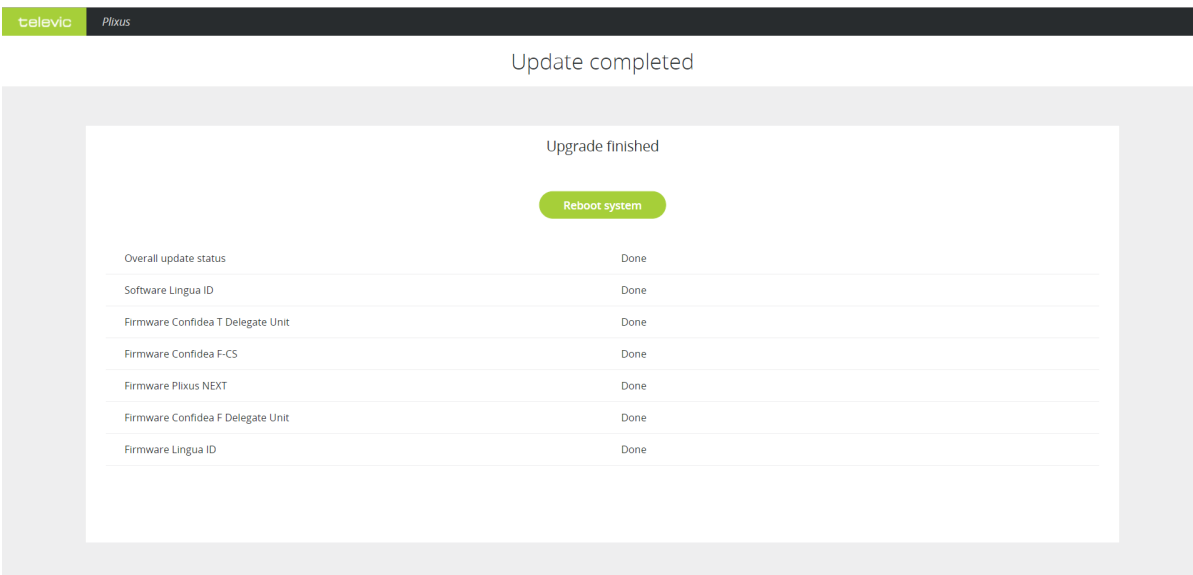

Figure 1-50 Reboot system after update



Golden firmware (version programmed during production process) will not be impacted by a CRP update. This firmware is used as a bootloader and used as fallback in case a failure occurs and unit doesn't boot to application software.

Different golden firmware versions have no influence on the functional performance of the system.



To be able to update the Confidea G3 WCAP and units, you need to uncouple these from the Plixus system and perform the update using the Confidea G3 web server. See the Confidea G3 user guide for more information.

Update Versions

Under **Version** you can find a list with all devices in the network (also units that are not yet initialized). Click **Download overview** to get a .txt file that contains all devices together with their serial numbers and firmware versions. You can use this as reference before the update.

If the system discovers a version mismatch, you will get an error message showing which devices are affected.

SYSTEM INFO

On the **System info** page, you can find all general system information.

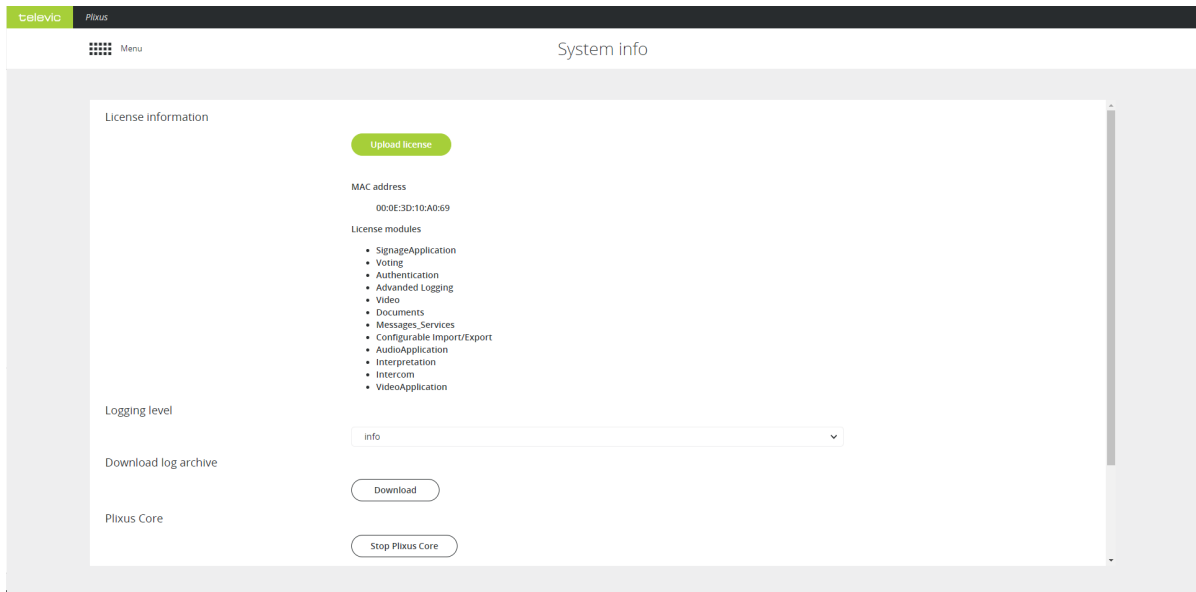

Figure 1-51 The System info page

Parameter	Description
License information	<p>Click Upload license to upload your CoCon license. Only license file with the correct MAC address (of the engine) will work. After upload this page shows all license details such as the licensed CoCon applications.</p> <p>The MAC-address is the address of the Plixus engine and corresponds to the one shown on the label of engine.</p>
Logging level	<p>Six log levels are available: fatal, error, warning, info, debug and trace</p> <p>Default value is Info.</p>
Download log archive	<p>Click the button to download all log entries.</p>
Plixus Core	<p>Click the button to activate or deactivate Plixus Core.</p> <p>Use this for functions that are not possible in Plixus Core and require CoCon. The web server will switch back to the old web server and you need CoCon Room Server for all functionality.</p> <p>It can take some time before the web server switches over.</p>

Parameter	Description
Import configuration	When you install a new engine you can import configurations. This can be interesting in case your previous system is defective or you have multiple comparable rooms.
Export configuration	Export your current configuration containing the following settings: <ul style="list-style-type: none"> > Initialization > Dynamics processing settings > Audio routing settings > Interpretation settings



Below you can find more information on the different log levels:

Fatal: are very severe errors that prevents the system from running.

Error: logs all unhandled exceptions; the system is still running.

Warning: designates potentially harmful situations that can effect the end user, but probably does not require immediate intervention.

Info: information that is useful to the running and management of your system.

Debug: designates fine-grained informational events that are most useful to debug an application.

Trace: provides even more details than debug. Selecting this option increases memory usage drastically.



Do not use the **trace** log level except when explicitly demanded by Televic Conference for debugging purposes, and for a short period of time. Due to increased usage of the internal processor as consequence of the large amount of data generated, the system may malfunction.

COUPLE WITH CONFIDEA G3

With Plixus it is possible to combine wired units with wireless ones. You can add one or more Confidea G3 WCAPs to your Plixus network simply by connecting them to one of the conference ports. For more information on the installation of the WCAPs in the Plixus network see "Install Confidea G3" on page 70



We advise to first couple wireless units with the WCAPs in standalone mode and upgrade units and WCAP to the latest version. When the devices need a new upgrade, you can simply uncouple and update the units in standalone mode using the Confidea G3 web server.

Couple WCAP With Engine

1. Select **Confidea G3 coupling**  in the main menu. This screen will show you all available WCAPs.
2. Click **Enable coupling** to connect with the Plixus system. After coupling you are able to see which frequencies the WCAPs are using together with their MAC address.

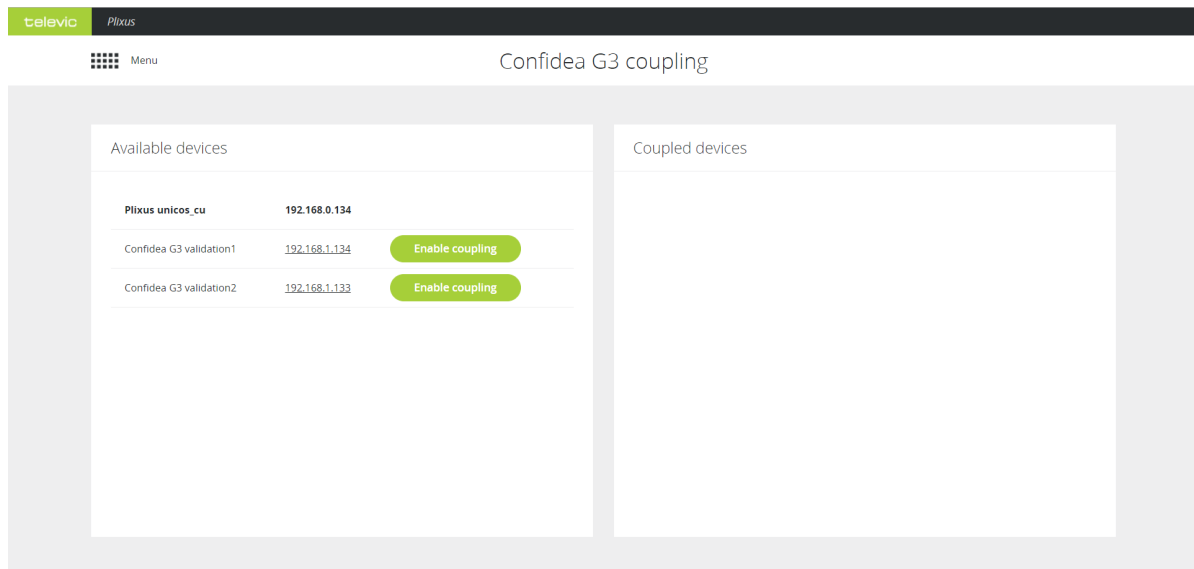

Figure 1-52 Couple Confidea G3 WCAP with Plixus

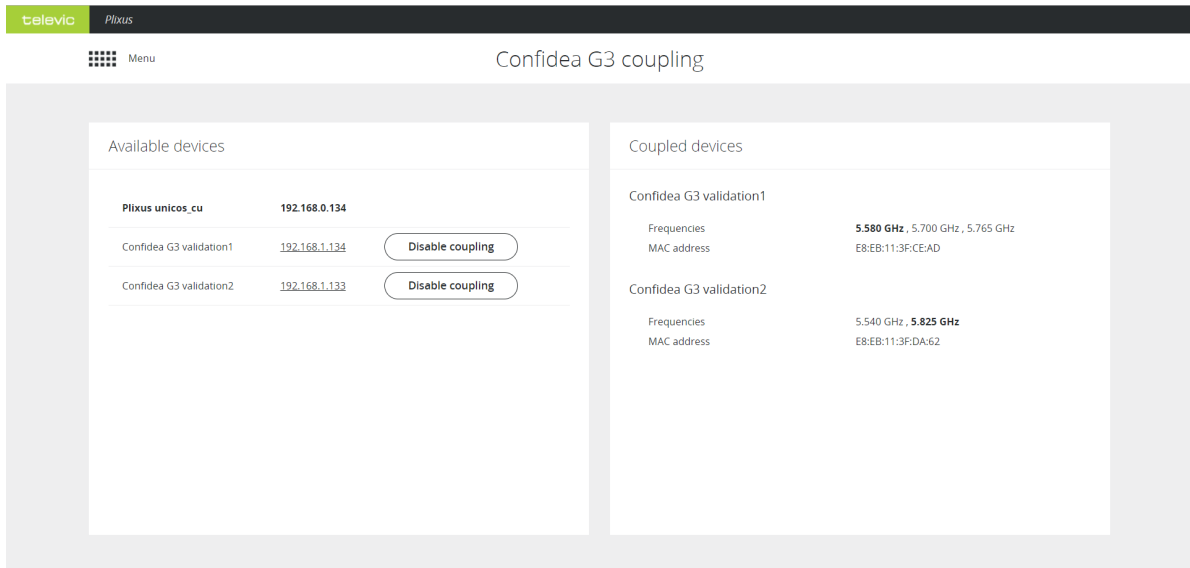
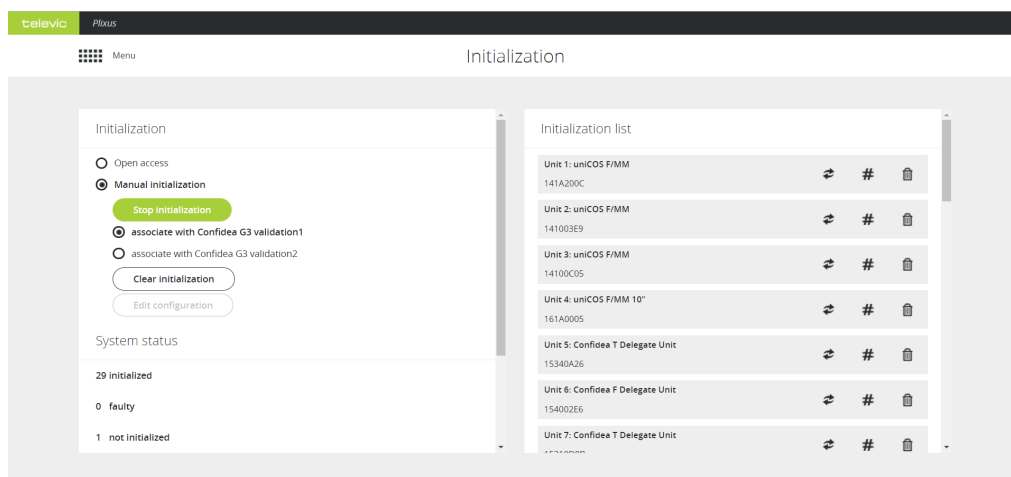

Figure 1-53 View coupled Confidea G3 WCAPs and their details

Associate Units With WCAP

1. Select **Initialization** from the main menu.
2. Click **Open initialization** to associate wireless units with the WCAPs.
3. Select the radio button of the WCAP you want associate the units with.



4. Press the microphone button from the units (red blinking LED) you want to associate with the WCAP. The LEDs of the units turn green when there initialized.
5. Select the radio button from the other WCAP(s) to associate units.

6. Click **Stop initialization**. For every wireless unit you can see the name of the WCAP they are associated with.

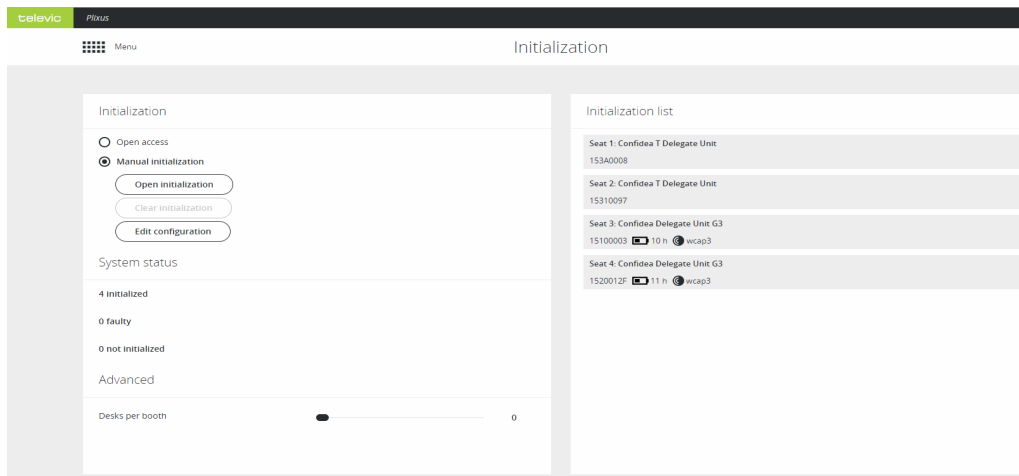

Takeover WCAP



To be able to transfer units from one WCAP to another, the WCAP you want to transfer units to can have **no units already associated** in Plixus. However, they can have units associated in standalone mode.

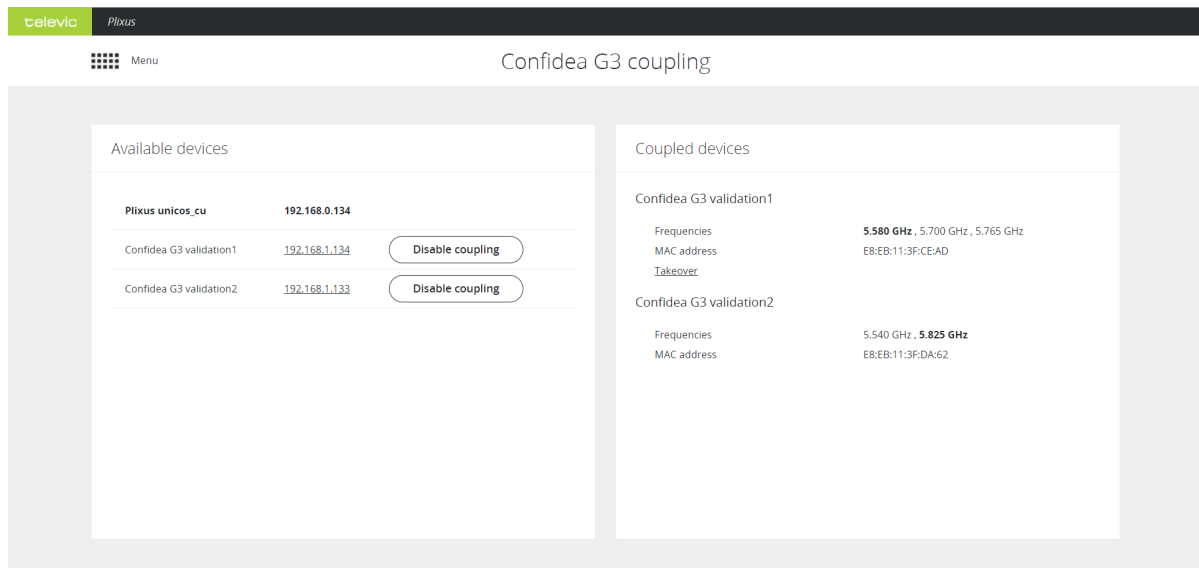
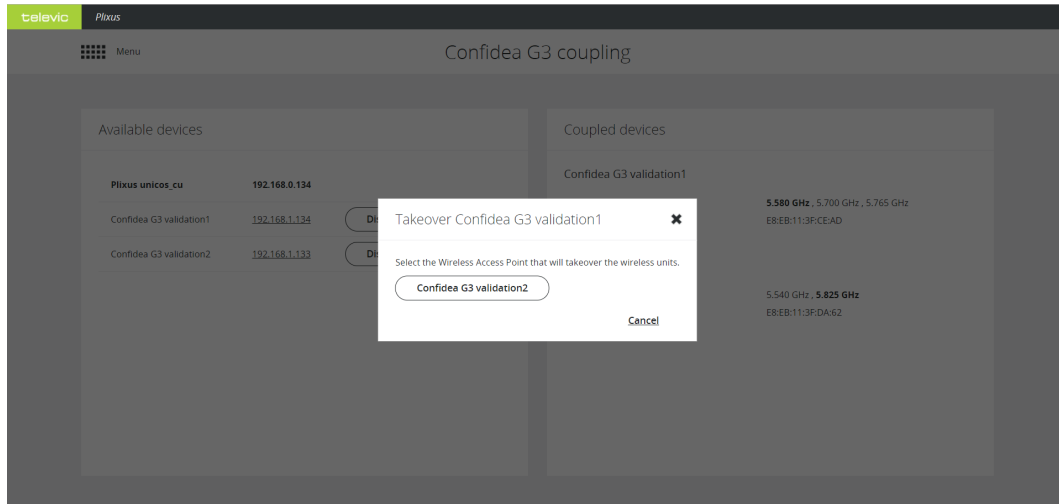

Figure 1-54 The Confidea G3 coupling page

1. Select **Confidea G3 coupling**  in the main menu.

2. When there is a WCAP available to transfer units to (i.e. with no units associated in the Plixus network) you will see the button **Takeover** under the WCAP that can transfer units. Click the button.

3. Select the WCAP to transfer the units to.



4. All units are now transferred to the selected WCAP.

TELEVIC CONFERENCE

Leo Bekaertlaan 1

8870 Izegem

Belgium

+32 51 30 30 45

GET IN TOUCH

